



TEMPERATURE CONTROLLERS... PORTABLE CHILLERS... CENTRAL CHILLERS... PUMP TANK STATIONS... TOWER SYSTEMS...

SUBJECT: TTK-450-2P PHYSICAL

#5-H-237

2/18/2000

NOTE: THIS DOCUMENT DOES NOT APPLY TO CURRENT PRODUCTION MODELS.

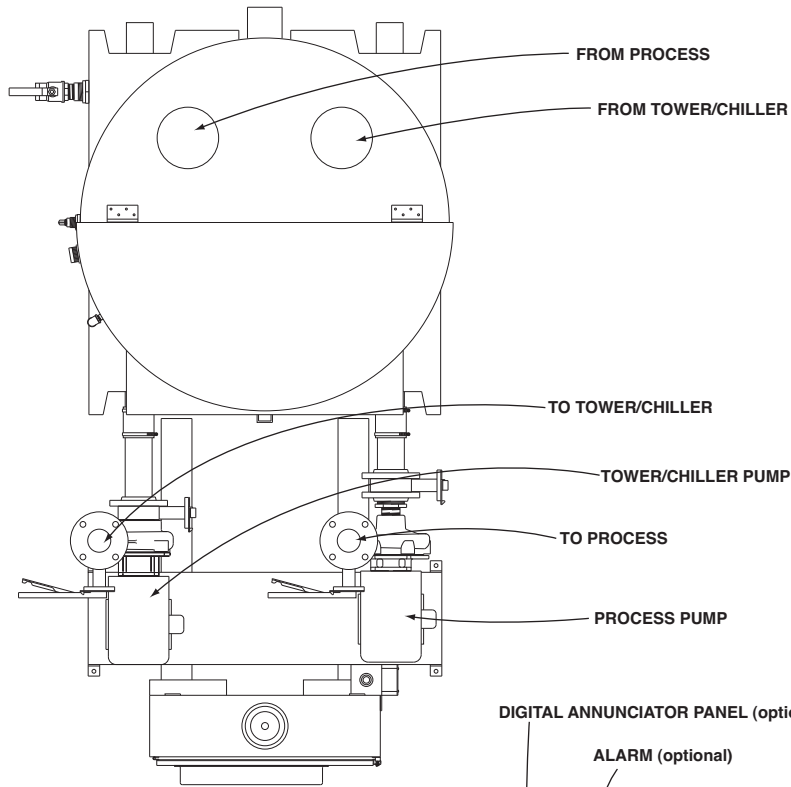

TYPICAL TTK-450 WITH PROCESS AND RECIRCULATION PUMPS. ACTUAL DIMENSIONS MAY VARY BASED ON SPECIFIC PUMP SELECTIONS.

