



TEMPERATURE CONTROLLERS... PORTABLE CHILLERS... CENTRAL CHILLERS... PUMP TANK STATIONS... TOWER SYSTEMS...

SUBJECT: TTK-1600-3P PHYSICAL

#5-H-234

2/18/2000

NOTE: THIS DOCUMENT DOES NOT APPLY TO CURRENT PRODUCTION MODELS.

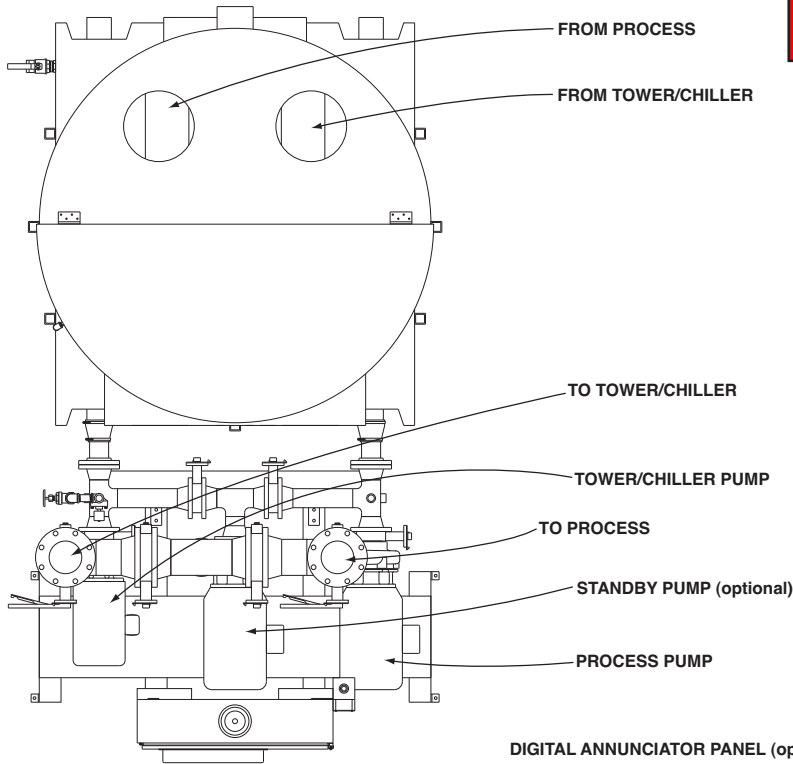

TYPICAL TTK-1600 WITH PROCESS, RECIRCULATION AND STANDBY PUMPS. ACTUAL DIMENSIONS MAY VARY BASED ON SPECIFIC PUMP SELECTIONS.

