

INSTRUCTION MANUAL • INSTALLATION • OPERATION • MAINTENANCE

TITAN

CENTRAL CHILLER®

**Covering Models From 20 - 180
Tons Air & Water Cooled**



Model: _____
Serial Number : _____

ADVANTAGE ENGINEERING, INC.
525 East Stop 18 Road Greenwood, IN 46142
317-887-0729 fax: 317-881-1277
Service Department fax: 317-885-8683
www.AdvantageEngineering.com
E-mail service@AdvantageEngineering.com

TITAN

CENTRAL CHILLER®

INSTRUCTION MANUAL AIR & WATER COOLED MODELS

With MZC III CONTROLLER



COVERING

INSTALLATION OPERATION MAINTENANCE



ADVANTAGE ENGINEERING, INC. 525 East Stop 18 Road Greenwood, IN 46142
317-887-0729 fax: 317-881-1277 Service Department fax: 317-885-8683
Website: www.AdvantageEngineering.com E-mail: service@AdvantageEngineering.com

TABLE OF CONTENTS

1.0	GENERAL	7
1.1	Introduction	8
1.2	Safety	8
1.3	Receiving instructions	10
1.4	Efficiency	10
1.5	Clean air act	10
1.6	Water Treatment	11
1.7	Model Designation	11
1.8	Components	12
2.0	INSTALLATION	13
2.1	General	14
2.2	Unit Location	14
2.3	Chilled Water Piping Installation	14
2.4	Water-Cooled Condenser (TI-W Models)	15
2.5	Air-Cooled Condenser (TI-A Models)	16
2.6	Make-Up Water Supply Connection	18
2.7	Electrical Connection	19
2.8	Air-Cooled Piping Installation (Typical)	22
2.9	Water-Cooled Piping Installation (Typical)	23
3.0	OPERATIONS	25
3.1	General	26
3.2	Start Up / Operation Procedure	26
3.3	Operator Controls	31
3.4	MZC Control Instrument	31
3.5	MZC Zone Board	41
3.6	Configuration switch adjustment (MZC only)	44
3.7	Controls	46
3.8	Pressure Gauges & Alarm Beacon	46
3.9	Digital Pressurestat Set Up	48
3.10	Zone Lead Lag	51
4.0	TROUBLESHOOTING	53
4.1	Unit Will Not Start	54
4.2	Compressor Hums But Will Not Start	54
4.3	Shuts Off On High Pressure	54
4.4	Shuts Off On Low Pressure	55
4.5	Compressor Shuts Off On Internal Overload	56
4.6	Low or No Process Pressure or Water Flow	56
4.7	Cooling Capacity Inadequate	57
4.8	Sensor	57
4.9	Coolant Pump	57
4.10	Chiller Controller	58

5.0	MAINTENANCE	61
5.1	Warranty Service Procedure	62
5.2	Periodic Preventative Maintenance	62
5.3	Special Maintenance	63
5.4	Solenoid Valve Service	64
5.5	Pump Seal Service	66
5.6	Checking Refrigerant Charge	69
5.7	Proper Cleaning Procedure for Brazed Plate Evaporators	69
6.0	COMPONENTS	71
6.1	Refrigeration Components	72
6.2	Coolant System	74
7.0	RELATED DRAWINGS	77
7.1	Titan Circuit Drawing	78
7.2	Typical Press Drop	79
7.3	Typical Vacuum Breaker / Anti-Siphon System	80
8.0	APPENDIX	81
8.1	Operations Below 48°F Fluid or 38°F Ambient	82
8.2	Refrigerant Pressure-Temperature Chart	85
8.3	Inhibited Propylene Glycol	86
8.4	Chiller Capacity & Derate Chart	86

THIS PAGE INTENTIONALLY BLANK

1.0 GENERAL

- 1.1 Introduction
- 1.2 Safety
- 1.3 Receiving Instructions
- 1.4 Efficiency
- 1.5 Clean Air Act
- 1.6 Water treatment
- 1.7 Model Designation
- 1.8 Components



1.1 INTRODUCTION

- A. This manual covers Titan central chillers from 20 to 180 tons (70 to 633 kW) of cooling capacity using the Advantage MZC (Multi Zone Control) microprocessor control instrument and fixed displacement scroll compressors and digital scroll compressors. The standard fluid operating temperature range for this chiller is 20°F to 80°F for units using R410A refrigerant. Units using other refrigerants have different standard operating ranges. Units operating below 48°F fluid require the use of a water/propylene glycol to prevent freezing. Customized units may have different operating ranges. Consult the factory if you have questions about the operating range of your chiller.
- B. The intent of this manual is to serve as a guide in the installation, operation and maintenance of your chiller. Improper installation can lead to equipment damage and poor performance. Failure to follow the installation, operation and maintenance instructions may result in damage to the unit that is not covered under the limited warranty. This manual is for standard products. The information contained in this manual is intended to be general in nature. The information is typical only and may not represent the actual unit purchased.
- C. Chemical refrigerants are used in this unit. The refrigerant is sealed and tested in a pressurized system however a system failure will release it. Refrigerant gas can cause toxic fumes if exposed to fire. Install this unit in a well-ventilated area away from open flames. Failure to follow these instructions and in accordance to all local and national codes, may result in a hazardous condition. Recover refrigerant to relieve pressure before opening the system. See nameplate for refrigerant type. Do not use non-approved refrigerants or refrigerant substitutes.
- D. Customers should implement a refrigerant management program to document the type and quantity of refrigerant in each chiller. All refrigeration service technicians performing work on this chiller must be licensed and certified.
- E. When calling for assistance from the Manufacturer's Service Department, it is important to know the model and serial number of the particular unit. The model number includes critical unit information which is helpful when troubleshooting operating difficulties. The serial number allows the service team to locate manufacturing and testing records which can have additional information relating to a particular unit.

1.2 SAFETY

- A. It is important to become thoroughly familiar with this manual and the operating characteristics of the unit.
- B. It is the owner's responsibility to assure proper operator training, installation, operation, and maintenance of the unit.
- C. Observe all warning and safety placards applied to the chiller. Failure to observe all warnings can result in serious injury or death to the operator and severe mechanical damage to the unit.
- D. Observe all safety precautions during installation, startup and service of this equipment due to the presence of high voltage and refrigerant charge. Only qualified personnel should install, startup and service this equipment.



WARNING: This equipment contains hazardous voltages that can cause severe injury or death. Disconnect and lock out incoming power before installing or servicing the equipment.



WARNING: This equipment contains refrigerant under pressure. Accidental release of refrigerant under pressure can cause personal injury and or property damage. Exercise care while working on or around this equipment.



WARNING: Vent all refrigerant relief valves in accordance to ANSI/ASHRAE Standard 15, Safety Code for Mechanical Refrigeration. This equipment should be located within a well-ventilated area. Inhalation of refrigerant can be hazardous to your health and the accumulation of refrigerant within an enclosed space can displace oxygen and cause suffocation

- E. When working on this equipment, observe precautions in literature and on tags, stickers and labels located on the equipment. Wear work gloves and safety glasses.

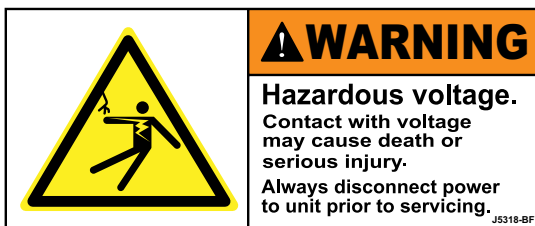

Samples of Warning Labels applied to typical chillers.

Alerts users to the danger of high voltage.



Alerts user to the danger of the rotating condenser fans on air condensed units.



Alerts user to the danger of belt drive systems on unit with blowers.



This symbol is seen on all chillers to alert user to the danger of the refrigeration system under pressure. System should only be serviced by a licensed technician.

1.3 RECEIVING INSTRUCTIONS

- A. Chillers are shipped skid mounted and wrapped in plastic prior to shipment. Check the overall condition of the equipment prior to accepting delivery.
- B. Check for visible damage and document any evident damage on the delivery receipt. Check copper refrigerant piping for visual cracks or signs of leaks. Shipping damage is the responsibility of the carrier.
- C. In order to expedite payment for damages, should they occur, follow proper procedures and keep detailed records. Take photographs of any suspected damage.

1.4 EFFICIENCY

- A. Long term efficiency of operation is largely determined by proper maintenance of the mechanical parts of the unit and the water quality. The Manufacturer recommends filtering the process water to prevent solids from plugging critical parts. The Manufacturer highly recommends that the services of a qualified water treatment specialist be obtained and their recommendations be followed. The Manufacturer accepts no responsibility for inefficient operation, or damage caused by foreign materials or failure to use adequate water treatment.

1.5 CLEAN AIR ACT



WARNING: Vent all refrigerant relief valves in accordance to ANSI/ASHRAE Standard 15, Safety Code for Mechanical Refrigeration. This equipment should be located within a well-ventilated area. Inhalation of refrigerant can be hazardous to your health and the accumulation of refrigerant within an enclosed space can displace oxygen and cause suffocation.

- A. Units manufactured after January 1, 2010 may contain refrigerant HFC-410A, HFC-407C, HFC-404A or HFC-134A. Most units manufactured prior to January 1, 2010 contain refrigerant HCFC-22.
- B. It is unlawful for any person in the course of maintaining, servicing, repairing, or disposing of refrigeration equipment to knowingly vent or otherwise dispose of any substance used as a refrigerant in the manner which permits such substance to enter the atmosphere.
- C. Very small releases associated with good faith attempts to recapture, reclaim or recycle such substance shall not be subject to the prohibition set forth in the preceding paragraph.
- D. Customers should implement a refrigerant management program to document the type and quantity of refrigerant in each chiller. All refrigeration service technicians performing work on this chiller must be licensed and certified.
- E. Vent all refrigerant relief valves in accordance to ANSI/ASHRAE Standard 15.

1.6 WATER TREATMENT



WARNING: Improper water treatment will void unit warranty.

- A. The use of untreated or improperly treated water in a portable chiller may result in scaling, erosion, corrosion, algae or slime.
- B. It is recommended that the services of a qualified water treatment specialist be engaged to determine what water treatment is required.
- C. Advantage assumes no responsibility for equipment failures which result from untreated or improperly treated water.
- D. Do not use deionized water in this unit. Some customized units may be compatible with deionized water. Consult the factory before using deionized water.

1.7 MODEL DESIGNATION

- A. The Serial Number identifies the exact configuration of your unit and should be available when contacting the Factory for service or information.
- B. There maybe additional numbers and letters at the end of the model number to indicate additional configuration options on the machine.

Typical placement of the Data tag.
Note: Data tag may be placed elsewhere on certain models.



Model Designator for Titan® Series Central Chillers

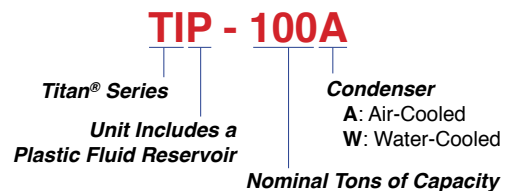

1.8 COMPONENTS

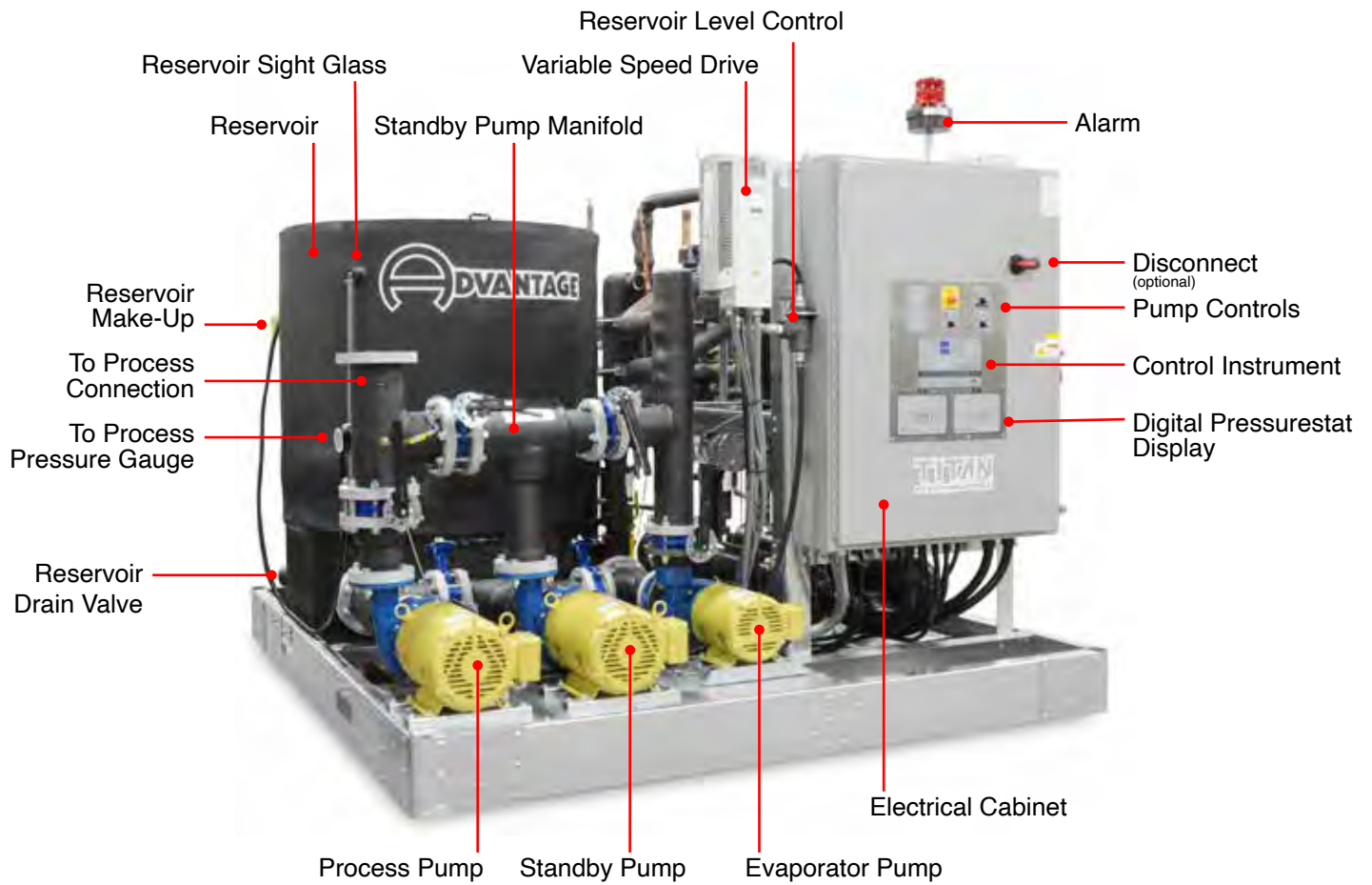

2.0 INSTALLATION

- 2.1** General
- 2.2** Unit Location
- 2.3** Chilled Water Piping Installation
- 2.4** Water-Cooled Condenser (TI-W Models)
- 2.5** Air-Cooled Condenser (TI-A Models)
- 2.6** Make-Up Water Supply Connection
- 2.7** Electrical Connection
- 2.8** Air-Cooled Condenser Installation (Typical)
- 2.9** Water-Cooled Condenser Installation (Typical)

2.1 GENERAL

- A. Check the overall condition of the equipment prior to accepting delivery. Check for visible damage and document any evident damage on the delivery receipt. Shipping damage is the responsibility of the carrier.
- B. All process piping materials (such as hose, rigid piping, valves or filters) used in process water piping circuitry must be rated for 100°F minimum temperature and 100 PSI minimum pressure.
- C. All such materials must have the equivalent or larger diameter of the particular process connection that length of process water piping is connected to.

2.2 UNIT LOCATION

- A. **Foundation.** The chiller must be installed on a rigid and level mounting surface with adequate strength to support the operating weight of the chiller including the weight of water and attached piping.
- B. Air-cooled units include an indoor portion (chiller) and remote outdoor condenser. The indoor unit contains the refrigeration circuits, pumping station and microprocessor control and is located inside the facility. The remote air-cooled condenser is located outside the facility.
- C. Water-cooled units include the refrigeration circuits, pumping station, microprocessor control and water-cooled condenser on a skid(s).
- D. For most efficient operation, locate the water-cooled unit and the air-cooled chiller in a level, clean, dry and well ventilated environment. Please note the air-cooled condenser (air-cooled models only) must be located outside of the facility.

2.3 CHILLED WATER PIPING INSTALLATION

- A. There are two piping connections on the unit. One is labeled **TO PROCESS**, and the other is labeled **FROM PROCESS**. Refer to typical drawings for recommended piping practices or optional plant layout drawing if supplied.

Typical reservoir lid and
From Process opening.



Typical **To Process** Connection.



- B. FROM PROCESS :** a rigid pipe should be connected to the return process header and dropped through the circular opening in the reservoir lid on the 'hot' side of the reservoir. The return water pipe must extend below the surface of the tank water during operation (approx. 1.5' above the bottom of the tank to prevent unwanted aeration of the process water). Cut the end of the return pipe at a diagonal and face the open side of the pipe end away from the pump suction ports of the tank.

From Process

This label marks the From Process connection

- C. TO PROCESS :** Connect the to process port to the process supply header.

To Process

This label marks the To Process connection

- D.** Install a high volume basket strainer in the To or From Process line with isolation valves. A basket strainer or bag filter with a 20 mesh (400 micron) or finer screen will protect the unit. Installing a filter that is too fine may be unnecessary and may result in frequent filter maintenance.

A "wye" type strainer is not recommended because it does not have adequate debris holding capacity.



Typical wye strainer - Not recommended.

- E.** Process water piping should be designed to avoid excessive elbows and/or lengths of pipe or hose. Insulation of these lines is recommended to prevent condensation and capacity losses due to heat absorption.
- F.** Valves and filters may be installed in the process water piping to facilitate service and maintenance provided that such devices maintain the full inside diameter of the process connection. If installed, all such devices must be open and clean during unit operation.

2.4 WATER-COOLED CONDENSERS (TI-W MODELS)

- A.** The TI-W chiller is designed for indoor use and should be located in a clean, dry and well-ventilated environment. The ambient temperature in the area should not be below 40°F.
- B.** TI-W chillers require an external water source at 85°F maximum temperature for the water-cooled condenser. Tower water is the most common selection. However, city or well water may be utilized. A water regulator valve is supplied to vary flow based on refrigerant discharge pressure.
- C.** Nominal flow rate requirements:
1. Required consumption from a city water source is 1.5 gpm at 65°F per ton of rated capacity.
 2. Required consumption for a tower water source is 3 gpm at 85°F per ton of rated capacity.
- D.** The pressure differential requirement between the condenser water in and water out connections must be a minimum of 30 PSIG to obtain adequate flow.
- E.** A water filter with 40 mesh or finer screen should be installed prior to the chiller to protect the condenser from debris. Basket type strainers are recommended rather than wye type strainers because they are generally more rugged and hold more debris.

Typical Water-Cooled Condenser Connections



Condenser Water In
This label marks the Condenser Water In connection

Condenser Water Out
This label marks the Condenser Water Out connection

TI-60W shown with optional standby pump and manifold.

2.5 AIR-COOLED CONDENSER (TI-A MODELS)

- A.** Air-cooled units have an indoor portion that contains the chiller's compressor, evaporator, control system and pumping station and a remote outdoor condenser that discharges the process heat outdoors.
1. The indoor portion of the system containing the compressor, evaporator, control system and pumping stations should be installed in a clean, dry and well ventilated environment where the ambient temperature will not go below 40°F.
 2. The remote air-cooled condenser is designed for outdoor installation normally selected for ambient air temperatures from -20°F minimum to 95°F maximum. Ambient conditions outside of the rated temperatures may require an alternate selections for proper operations.
- B.** Refrigerant piping for remote outdoor condenser models:
1. Only refrigerant grade copper and solder shall be used.
 2. The refrigerant line sizes shall be based on equivalent line lengths and acceptable refrigerant pressure drops.
 3. A certified refrigerant technician shall evacuate and charge the refrigerant system under loaded conditions.

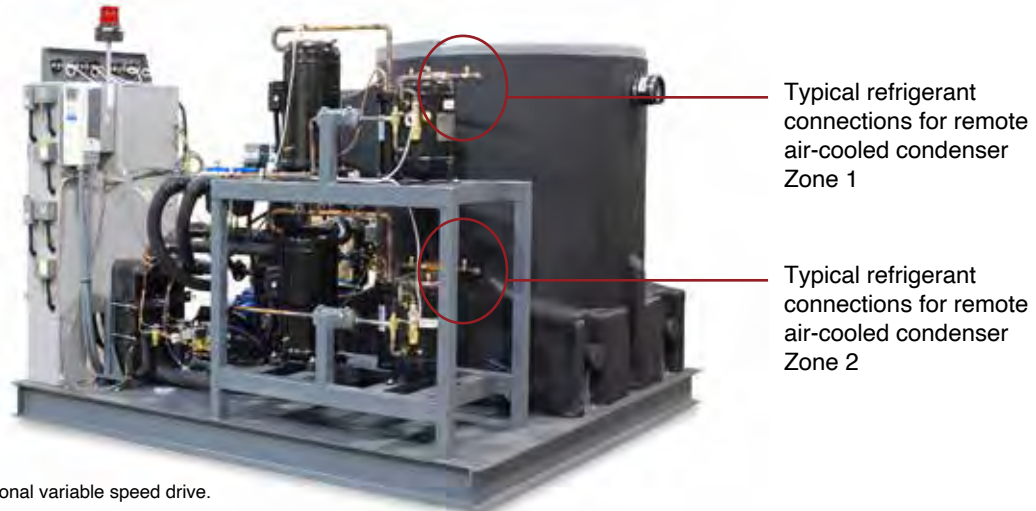

TI-60A shown with optional variable speed drive.

- C.** Installation instructions are provided by the manufacturer of the condenser and are shipped in the electrical cabinet of the condenser. The following is a short overview of the instructions.
- D.** The condenser is designed to be rigged from overhead. Lifting holes are provided and marked.
- E.** The unit should be located in an area free of foreign material which could clog the condenser air intake. It should be located on a hard level surface, a concrete pad is recommended.
- F.** Interconnecting refrigerant piping is field supplied and installed. Only refrigerant approved copper should be used. Water piping and soft solder joints are not acceptable. High temperature phos-copper should be used on all joints.
- G.** The following should be field provided and installed in the interconnecting piping :
 - 1.** Discharge line check valves installed after the oil separator (if not already supplied with the chiller).
 - 2.** Shut off valves in the hot gas and liquid lines.
 - 3.** Pressure relief valves located at the condenser.
 - 4.** Refrigerant recovery ports located at the condenser.
 - 5.** Inverted traps in the refrigerant piping (refer to typical piping schematic).
- H.** The electrical installation must conform to all national and local electrical codes. Refer to the electrical schematics for actual circuit design.
- I.** Remote outdoor condenser installation should include:
 - 1.** Hot gas lines should rise above refrigerant level in condenser circuit.

2. Trap should be installed on hot gas lines to prevent condenser oil and refrigerant vapor migration from accumulating on compressor heads during off cycle.
3. Condenser refrigeration piping sized by refrigeration contractor based on specific installation.
4. For piping lengths greater than 50 ft provide support to liquid and gas lines near the connections to the coil.

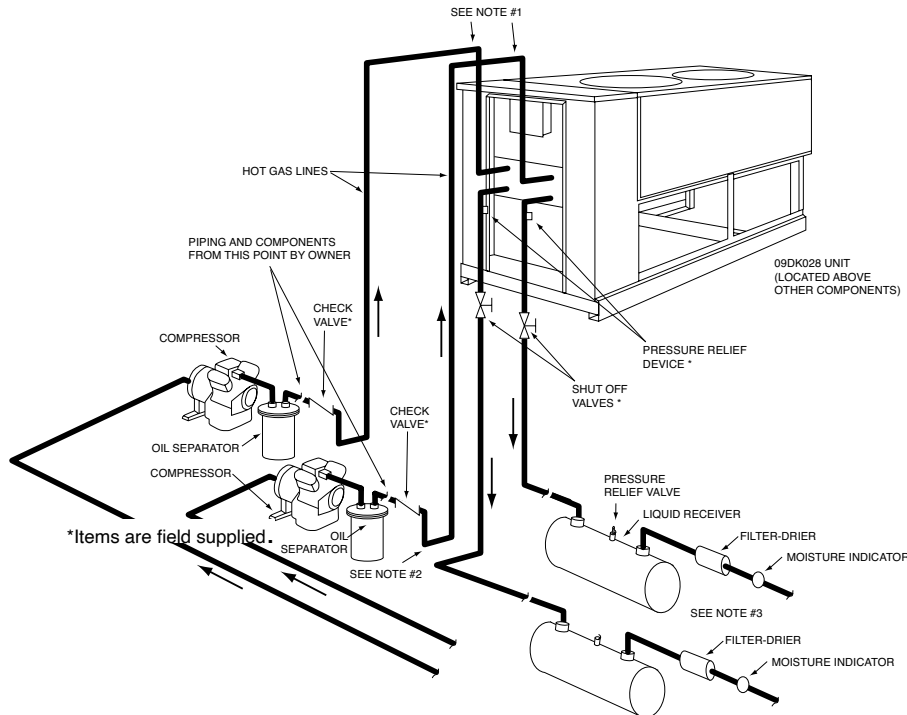

2.6 MAKE-UP WATER SUPPLY CONNECTION

Water Make-up

This label marks the Water Make-up connection

- A. The automatic water make-up system continually monitors the reservoir tank and fills it when needed. Connect as follows:
 1. Using appropriately rated hose or fluid piping connect the "water make-up" connection to the plant's water source.
 2. Minimum make-up water supply pressure is normally 20 psi.
 3. Install an owner supplied shut off valve in the make-up water supply line. Install this valve on the outside of the unit.
 4. Use a back flow prevention device as may be required by local codes to prevent possible contamination of potable water.
- B. Do not use automatic water make-up system when operating with glycol below 48°F.



WARNING: Check local codes to determine proper use of back flow prevention device in water make-up supply line.

Typical location of Water Supply connection.



2.7 ELECTRICAL CONNECTION

A. STANDARD MODELS

1. All electrical wiring must comply with local codes and the National Electric Code.
2. Electrical power supply requirements for standard units are identified on the equipment data tag. Determine that the plant's voltage supply is the same as the unit's voltage requirements, taking into account the SSCR Rating.
3. A customer supplied, four conductor cable is required for connection to a customer supplied fused disconnecting means. The fused disconnecting means shall be sized and installed according to the unit's power supply requirements and local electrical codes. (Some custom units may include a fused or non-fused disconnect switch.)
4. Connect the four conductor power cable to the power entry terminal block on the unit's electrical panel. Then connect the power cable to the fused disconnect switch. There is no power entry hole into the electrical cabinet. This allows the matching of the entry hole size and location to the customer supplied fittings.
5. A unit specific electrical drawing is shipped with the unit.



WARNING: Do not connect the unit to a voltage supply not equal to the unit's voltage requirements as specified on the unit's data plate. Use of incorrect voltage will void the unit's warranty and cause a significant hazard that may result in serious personal injury and unit damage.



WARNING: Electric Shock Hazard. High Voltage is present in the electrical cabinet. Disconnect power before servicing. Follow all facility lock-out tag-out procedures.

6. Voltage supplies must be within +/- 10% of the name plate voltage and must be within 2% from leg to leg. Extreme voltage imbalance or using the wrong voltage can damage your chiller and cause premature unit failure as well as a safety risk.

7. A proper ground is required for the unit.

B. CONTROL CIRCUIT WIRING

1. The unit's supplied control circuit is 110 volt, 1 phase, 60 cycle.
2. The control circuit is supplied by the factory installed transformer. A control circuit fuse is provided.

C. GENERAL

1. Make certain all ground connections to the unit are properly affixed.
2. Make certain power conductor, disconnecting means, and fusing are properly sized according to the unit's power supply requirements.
3. Follow all local and national codes.
4. Make certain that all owner and factory wire connections are tight before applying power to the unit.

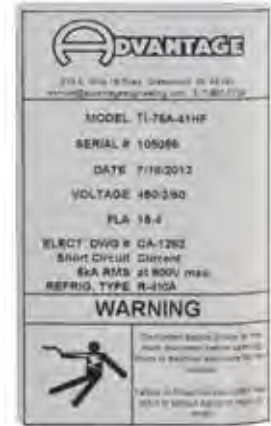

Typical data tag.



WARNING: Check that all electrical connections are tight before starting. Disconnect power before servicing. Follow all facility lock-out tag-out procedures.

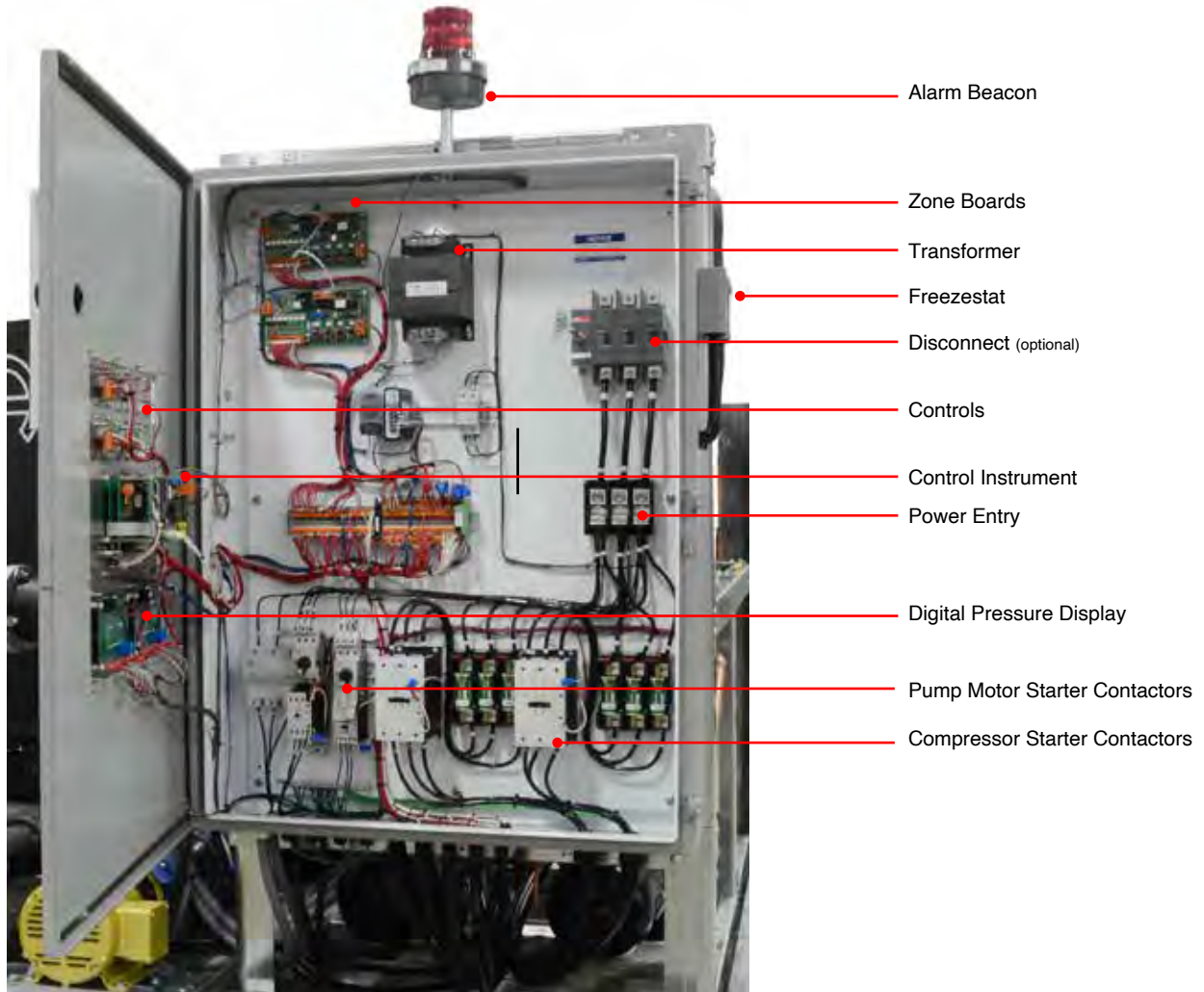

Typical electrical panel show. Refer to the electrical drawing provided for details to the particular unit.

2.8 Air-Cooled piping installation (typical)

1. Chiller (air-condensed, 2 pump system with standby pump)
2. Water make-up connection (chiller reservoir)
3. From city water supply (reservoir make up)
4. Overflow connection (chiller reservoir)
5. Pump discharge connection (supply to process)
6. Condenser (Zone #1, remote outdoor unit, mounted at ground level on concrete pad or on roof)
7. Condenser (Zone #2, remote outdoor unit, mounted at ground level on concrete pad or on roof)
8. Condenser refrigeration piping (sized by refrigeration contractor based on specific installation)
9. Reservoir Drain Connection
10. Filter (MLS Series In-Line full flow design - see piping options)
11. Water inlet connection (filter)
12. Water outlet connection (filter)
13. Bypass pipe with valves (redirection of process water flow during filter service)
14. Drain-back dam (keeps header pipes full during shut-down periods)
15. Main header valves (closed for header service or during use of alternate source of cooling water)
16. Alternate source of cooling water on/off valve (for system emergency back up)
17. Alternate water supply source (for system emergency back up)

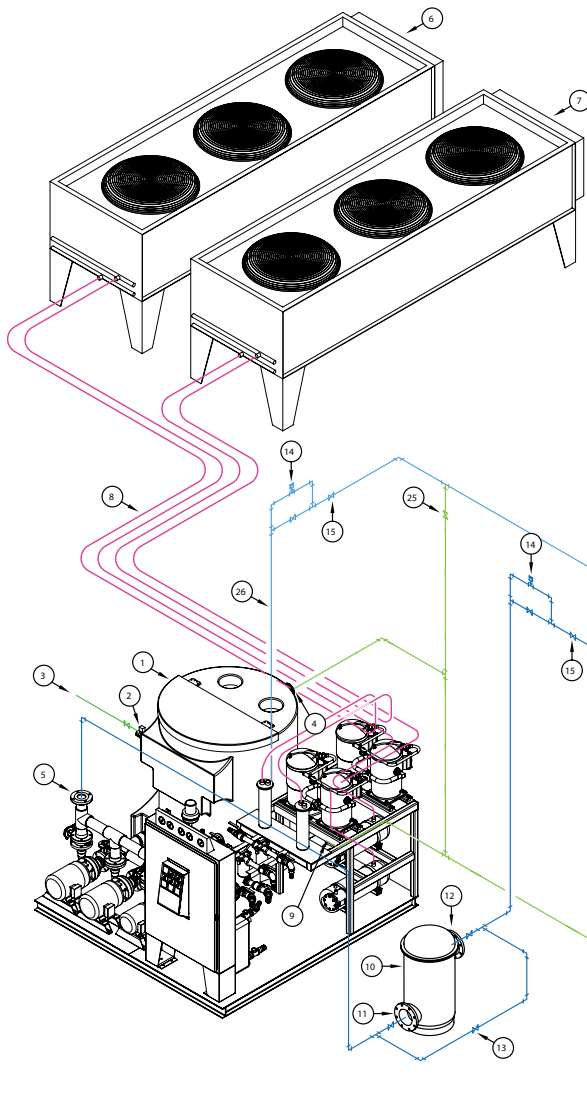

18. System multi-use open drain (reservoir overflow, reservoir drain, system emergency back up)
19. Process water drops from header to use point (valved for service shutoff)
20. Pressure gauge and thermometer (for system performance monitoring and evaluation)
21. Header ends valved and capped (for future expansion)
22. Header by-pass valve (adjustable and pressure activated to maintain flow in header during low process demand)
23. Branch header valves (for branch header service isolation)
24. Branch header
25. Valve to open drain (for system emergency back-up)
26. From process return pipe

This drawing is supplied to demonstrate a possible piping configuration for the equipment and is general in nature showing pipe sizes and basic routing. It is not intended to be inclusive of every detail required for specific location and installation. Consult with a professional engineer to determine specific needs before installation.

2.9 WATER-COOLED PIPING INSTALLATION (TYPICAL)

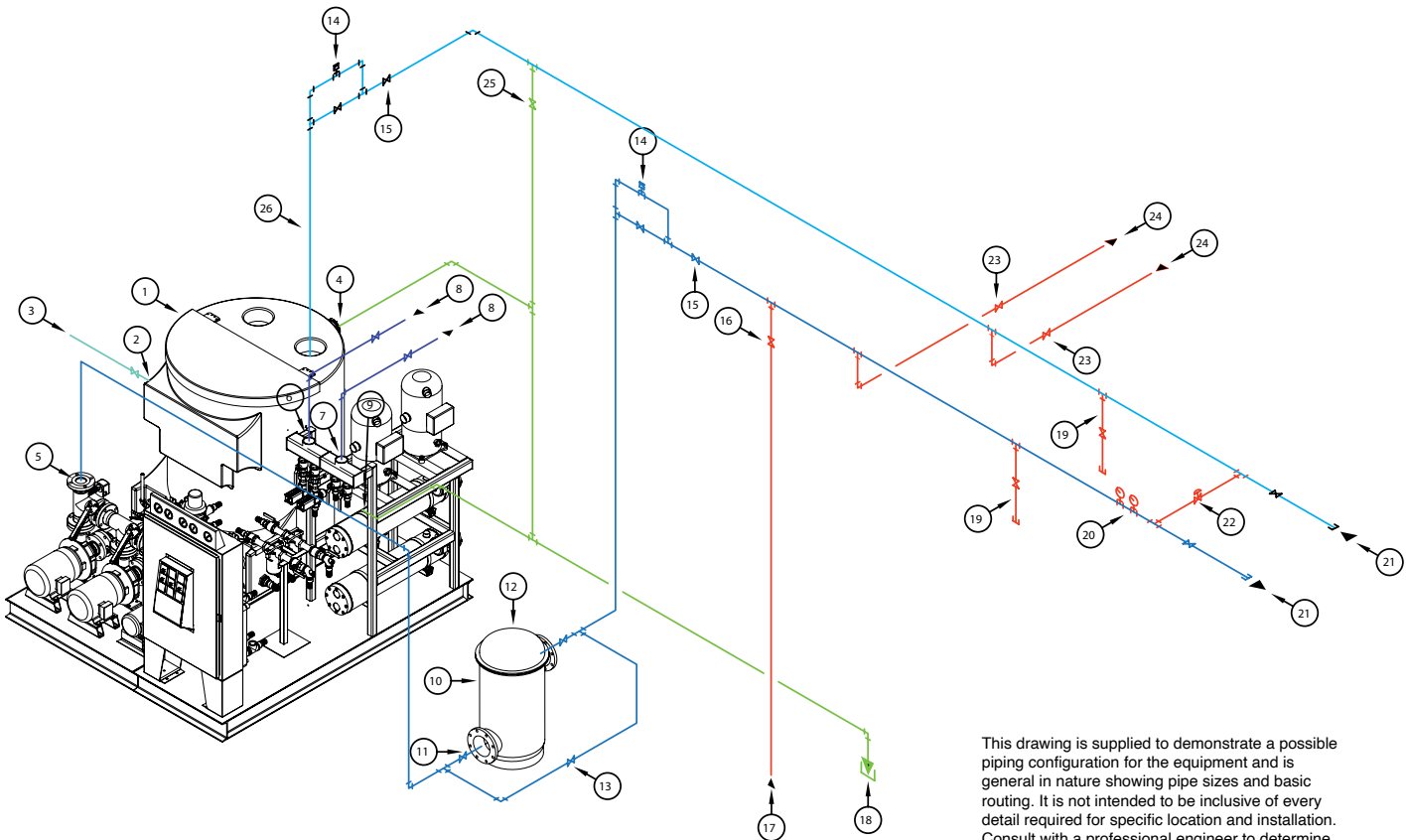

This drawing is supplied to demonstrate a possible piping configuration for the equipment and is general in nature showing pipe sizes and basic routing. It is not intended to be inclusive of every detail required for specific location and installation. Consult with a professional engineer to determine specific needs before installation.

1. Chiller (2 pump system with standby pump)
2. Water make-up connection (chiller reservoir)
3. From city water supply (reservoir make up)
4. Overflow connection (chiller reservoir)
5. Pump discharge connection (Supply to process)
6. Condenser connection (supply from cooling tower or city water)
7. Condenser connection (return back to cooling tower or if using city water - return to open drain)
8. Condenser water pipes
9. Reservoir Drain Connection
10. Filter (MLS Series In-Line full flow design - see piping options)
11. Water inlet connection (filter)
12. Water outlet connection (filter)
13. Bypass pipe with Valves (redirection of process water flow during filter service)
14. Drain-back dam (keeps header pipes full during shut-down periods)
15. Main header valves (closed for header service or during use of alternate source of cooling water)
16. Alternate source of cooling water on/off valve (for system emergency back up)
17. Alternate water supply source (for system emergency back up)
18. System multi-use open drain (reservoir overflow, reservoir drain, system emergency back up)
19. Process water drops from header to use point (valved for service shutoff)
20. Pressure gauge and thermometer (for system performance monitoring and evaluation)
21. Header ends valved and capped (for future expansion)
22. Header by-pass valve (adjustable and pressure activated to maintain flow in header during low process demand)
23. Branch header valves (for branch header service isolation)
24. Branch header
25. Valve to open drain (for system emergency back-up)
26. From process return pipe

THIS PAGE INTENTIONALLY BLANK

3.0 OPERATIONS

- 3.1** General
- 3.2** Start Up / Operations Procedure
- 3.3** Operator Controls
- 3.4** MZC Control Instrument
- 3.5** MZC Zone Board
- 3.6** Configuration Switch Adjustment - MZC Instrument Only
- 3.7** Controls
- 3.8** Pressure Gauges & Alarm Beacon
- 3.9** Digital Pressurestat Set Up
- 3.10** Zone Lead Lag



WARNING: Follow all Factory operations procedures. Failure to do so may create a hazardous operating condition which may result in serious operator injury and/or unit damage.

3.1 GENERAL

- A. Failure to follow the factory required operations procedure may adversely affect the unit's ability to adequately control process temperature and may create a hazardous operating condition which may result in serious operator injury and/or unit damage.
- B. The OPERATIONS segment of this manual is divided into the following sections:
 - 3.2 **Start up/operations** - follow this segment to start the unit after the initial installation to the process system or to restart the unit after re-installation to the same or different process system. This section includes information on system fill, electric motor phasing (motor rotation) and process flow adjustments.
 - 3.3 **Chiller Control** - follow this segment to start up and operate the chiller control. This section includes information on setpoint selection and adjustment, and feature explanations.
 - 3.4 **Shut down procedure** - follow this segment to shut down the unit. This segment includes information on system shut down, electrical power supply precautions, and disconnection from system.

3.2 START UP / OPERATION PROCEDURE

- A. **IMPORTANT** - Prior to starting the chiller verify that the low and high refrigerant pressure limit settings are set per the pressure settings chart and instructions in section 3.9 of this manual for the fluid operating temperature. Failure to have these settings correct may cause damage to the chiller which is not covered by the chiller warranty.
- B. **System Fill**
 - 1. For operating temperatures from 48°F to 80°F use water to fill the unit. For operating temperatures below 48°F a water and propylene glycol mixtures must be used. An inhibited propylene glycol can be used for operating temperatures above 48°F if desired to prevent corrosion and scaling. Use the minimum ratio that is recommended by the glycol manufacturer. See section 8 of this manual for more information.
 - 2. The unit has an internal reservoir which must be filled and maintained for proper operation. The unit has a level switch mounted at the proper water level in the reservoir.
 - 3. **WATER QUALITY CONTROL.** Lack of, as well as, improper water treatment can damage the chilling unit. The services of competent water treatment specialist should be obtained and their recommendations followed. It is the equipment owner's responsibility to prevent damage from foreign material or inadequate water treatment. See water treatment section in **section 1.6** of this manual for more information.

4. **FOR AUTOMATIC FILL:** Always install a manual shut off valve on the make-up water supply on the outside of the unit. When electrical power is applied to the unit but the On/Off Selector is in the 'off' position open the owner supplied shut off valve. The level switch will activate the make-up solenoid which will open and the water supply will fill the reservoir tank. **Do not use automatic fill when operating at temperature below 48°F.**
5. **MANUAL FILL:** Add fluid directly to the reservoir. When the pump is first started, as process lines are filled and air is purged, additional fluid may be required to restore the reservoir to the correct level. Verify reservoir level via the coolant sight glass.

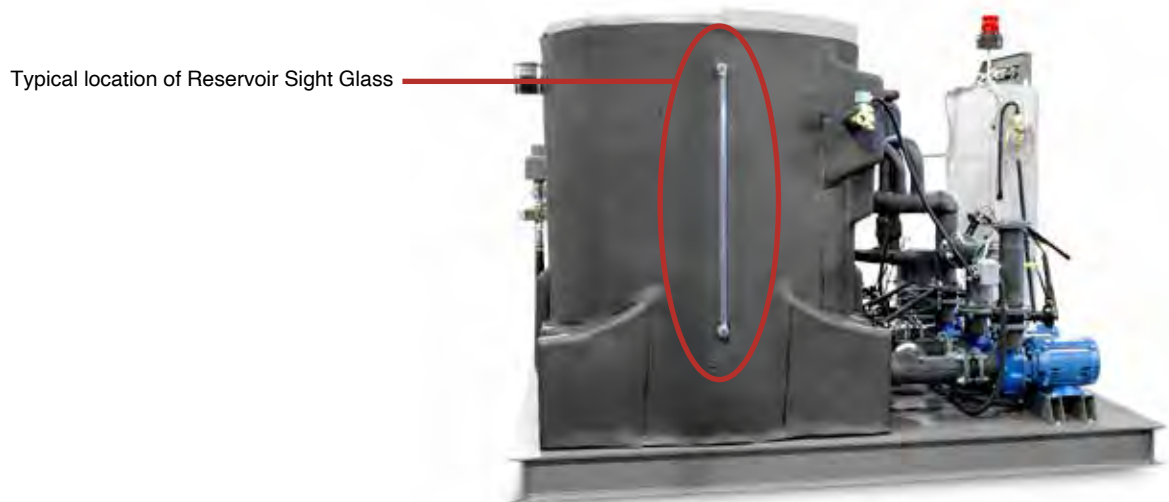

6. Do not use deionized water in this unit unless your unit was specifically designed for use with deionized water. Consult factory if not certain.
7. The tank is normally equipped with an automatic water make-up system. One of several automatic make-up systems may be used on your system.
 - a. Mechanical automatic water make-up with a Hudson Float.
 - b. Mechanical level switch that activates a solenoid valve where the level switch is located outside of the tank.
 - c. Ultrasonic switch that activates a solenoid valve as described in Section 8.5 of this manual.

C. PROPER ROTATION (PHASING) OF SCROLL COMPRESSORS & PUMPS & FANS

1. Correct compressor and pump rotation is critical for unit performance and to avoid severe damage to the compressor.
2. All models, excluding remote outdoor condenser systems, have their compressor and pump motors factory phased in unison. Therefore, you should only need to

check one motor to verify phasing. However, we recommend verifying all motor rotations.

3. After electrical installation the rotation must be checked by observing the pump motor shaft on the end of the pump and comparing its rotation to the directional arrow on the motor.
4. If the rotation needs to be changed it should be done at the main power entry by switching any two power conductors at the terminal block or customer supplied main power disconnect. Recheck rotation before operating the units.
5. Caution must be taken when checking rotation to avoid electrical shock.
6. A scroll compressor may make a loud rattling noise when rotating in the wrong direction.
7. Operating the scroll compressor in the wrong direction will cause the unit to trip on it's internal temperature limit and may cause unit damage. When the temperature limit trips, the compressor must be allowed to cool before it will restart. This may take substantial time.
8. Procedure to set proper rotation:
 - a. Supply electrical power to the unit. Once the correct voltage is supplied to the unit, the POWER switch on the unit's control panel will illuminate. Adjust the setpoint to 70°F or higher to prevent the compressor from activating during this procedure.
 - b. Remove all necessary cover panels to access the pump motor.
 - c. Locate the pump's electric motor. The operator must identify the motor shaft inside the electric motor housing. The motor shaft can be seen through the vent slots in the motor housing or by removing the shaft cover.
 - d. Toggle the Pump ON/OFF switch. This will quickly cycle the pump motor "on" and then "off".

Pump Control Switch



- e. Observe the motor shaft. When the ON/OFF SWITCH is on, the motor shaft will rotate. When switched off, the shaft will slowly "coast" to a stop. As the shaft slows, the operator can identify the rotation of the motor shaft. Correct rotation (correct phase) is "clockwise", when viewed from the rear of the motor. Incorrect rotation is "counter-clockwise" (incorrect

phase) when viewed from the rear of the motor. If the shaft does not rotate when the ON/OFF SWITCH is on, the operator must identify the cause as outlined in the troubleshooting and repair section of this manual.



Correct shaft rotation is clockwise.

- f. If the motor shaft is phased correctly (shaft turns in a clockwise direction), continue with **step C**. If the motor shaft is **NOT** phased correctly (shaft turns in a counter-clockwise direction), correct as outlined in **step 2**.

2. If the unit is phased **incorrectly**, the operator must:

- a. Disengage the electrical power supply to the unit at the unit's disconnect switch. Follow all facility proper lock-out tag-out procedures before proceeding.
- b. Once the electrical power supply is disengaged the operator can change rotation by switching any two power conductors at the terminal block or customer supplied main power disconnect.

D. PROCESS FLOW ADJUSTMENTS

1. The operator must determine and set proper water flow rate for the most efficient and trouble free operation.
 - a. Water flow rate through the process is determined by the pressure losses in the process loop. Generally, higher flow rates result in turbulent flow achieving maximum temperature control and lower maintenance. Since the evaporator in most liquid chillers is flow sensitive, the efficiency of operation is directly related to the flow of liquid.
 - b. Maximum chiller efficiency is obtained at approximately 2.4 gpm per ton of rated capacity. Low liquid flow can reduce efficiency and in some cases allow ice to develop in the evaporator which can damage the evaporator. Excessive liquid flow will trip the motor overload protection circuit.
2. **Excessive flow will cause the motor to operate at high amperage and eventually open the thermal overload safety shutting off the motor.** To correct this problem, a throttling valve must be installed in the from process line. With the throttling valve fully closed, slowly open the valve until the correct motor amperage is achieved. Motor amperage rating may be acquired on the motor nameplate.
3. **Low flow may result in poor temperature control and high temperature rises.** To correct this problem, a bypass system must be installed between the to and from process lines. With the bypass valve fully closed, slowly open the valve until the correct motor amperage is achieved. Motor amperage rating may be acquired on the motor nameplate.

- D. ADJUSTMENT OF CENTRIFUGAL PUMP.** When starting a piece of equipment with a centrifugal pump, it is important to properly set the flow rate to prevent overloading of the electric motor. The following example is the start up procedure for a two pump central chiller.

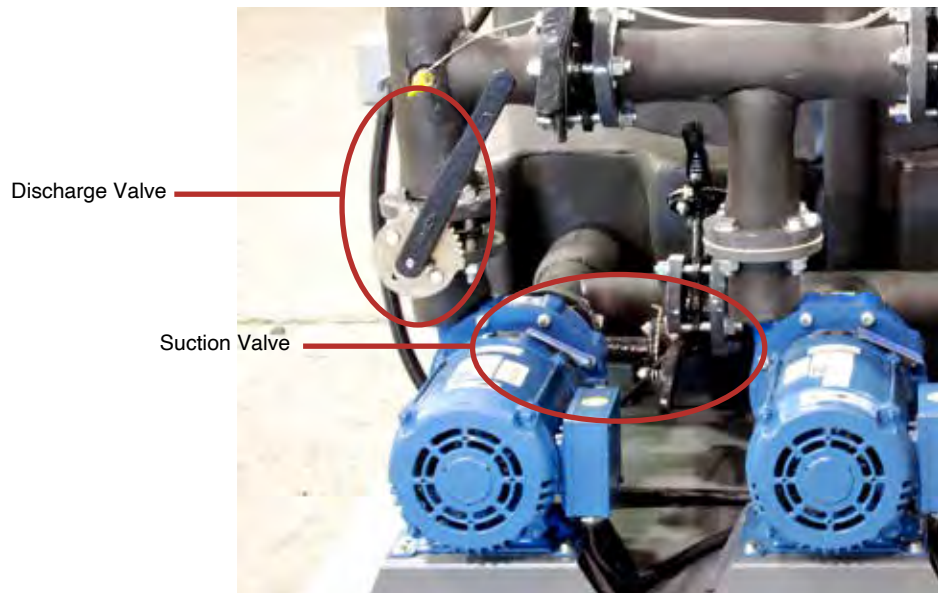

1. Fully open the suction valves to the pumps allowing the pump case to fill with water. Never allow the pump to operate dry, this can cause shaft seal failure.
2. Close the discharge valves. A centrifugal pump can be operated with no flow without damage, although this should not be for an extended period of time. Internal friction will cause the water in the pump case to overheat.
3. Place an amp meter on one leg of the process pump leads at the motor starter block and start the motor. Slowly open the discharge valve allowing the process piping to fill with water. After flow is established, continue to open the discharge valve. The amp draw will increase as the flow increases until you reach the run load amp rating listed on the motor data tag.
4. **Please note:** On initial start up the water use points may not be sufficient to fully load the motor, as you add use points you should recheck the amp draw on the motor and adjust the discharge valve as needed to prevent overloading of the motor.
5. Place an amp meter on one leg of the tower pump leads and start the motor. Slowly open the discharge valve allowing the piping to fill with water. After flow is established, continue to open the discharge valve. The amp draw will increase as the flow increases until you reach the run load amp rating listed on the motor data tag.
6. Never operate a pump without water in the case or never operate a pump without checking for proper amp draw.

7. Always operate the pump with the suction valve fully open. Adjust the amp draw with the discharge valve starting from a closed position. Starting from a wide open position can give a false reading and result in motor failure.
8. If during operations the motor overload trips, the overloads will need to be manually reset to restart operations. Once the pump is restarted, check for excessive motor amps at the motor starter block and throttle back the pump's discharge valve as required.

3.3 OPERATOR CONTROLS

A. Depending on the unit's standard and option configuration, the number of switches and buttons maybe different than shown below. A typical configuration is shown here.

B. **Operator Controls**

1. **MASTER STOP / STOP.** This controls the overall operation of the unit. In the On position, the unit can operation. In the Off position, the unit will not operate even if power is applied to the unit. A power indication is provided.



Master Start / Stop

2. **EMERGENCY STOP.** This mushroom type button will instantly stop all unit operation.



Emergency Stop

3. **PUMP CONTROL.** This controls the operation of the pump. Each pump will has it's own control. There is 3 operations in this single control:

- a. **On / Off switch.** Turn On to activate the pump and Off to deactivate.
- b. **Running Light.** When the pump is operating this light will glow Amber.
- b. **Overload Trip Light.** If the pump has tripped on the overload relay, this light will glow red.



Pump Control

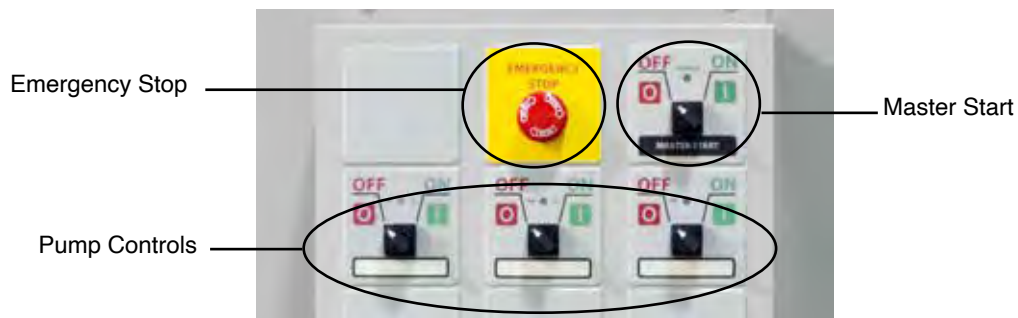

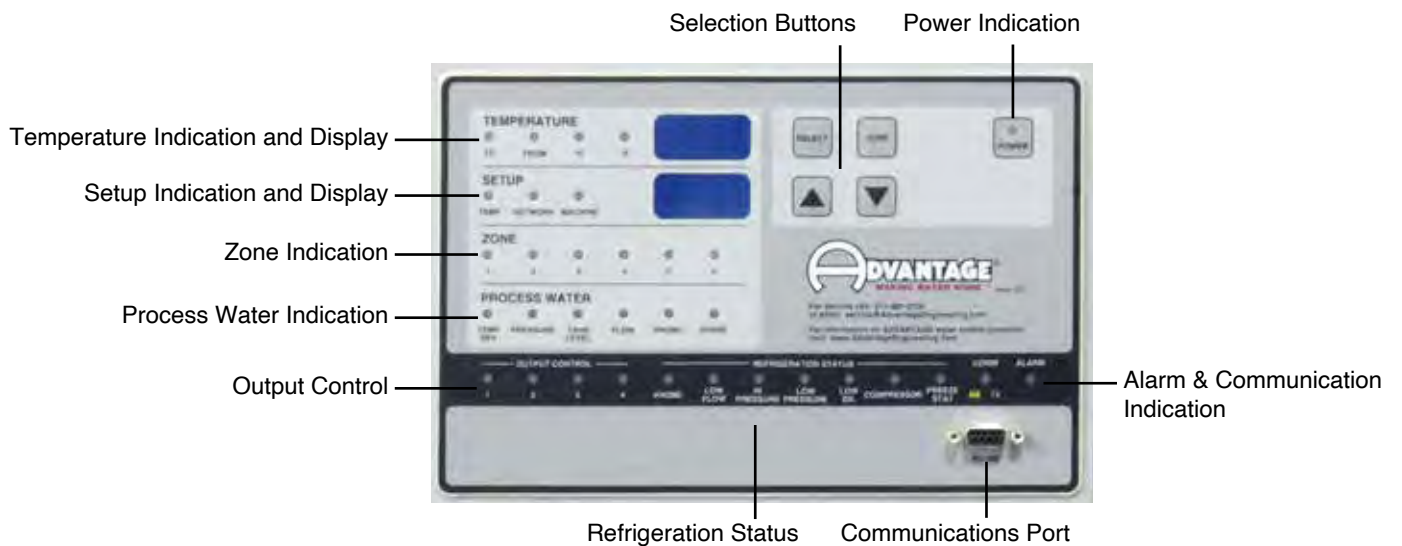
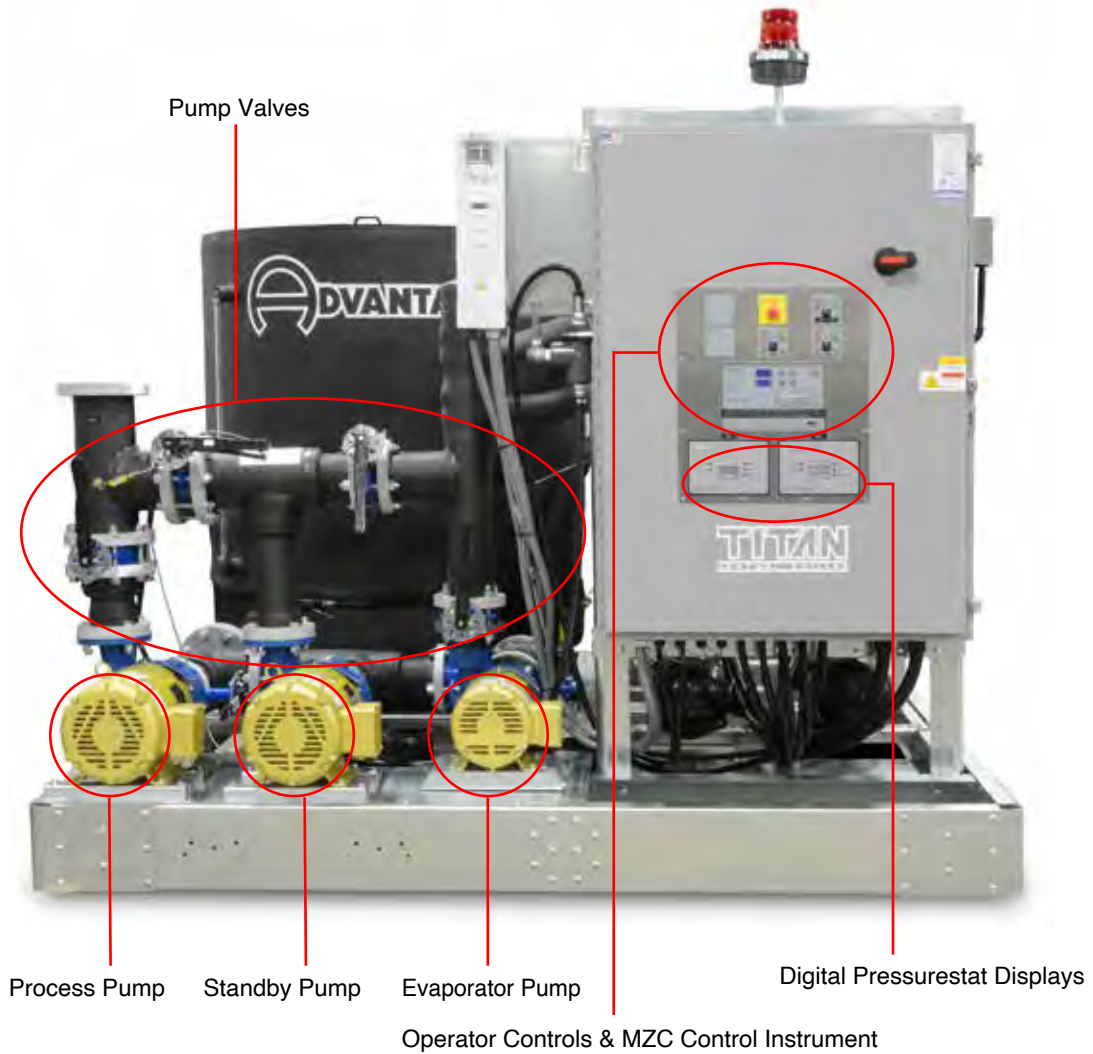

3.4 MZC CONTROL INSTRUMENT

A. OPERATION NOTES

1. The chiller control is programmed from the factory with a setpoint range of 48°F - 90°F. To operate below 48°F, inhibited glycol must be added to the system and the system limit switches must be adjusted. In addition to the operating range of the chiller control instrument must be modified by changing the DIP switch on the control panel to allow for a wider setpoint range. Refer to section 8 of this manual for more information.
2. Diligent monitoring of the water/glycol solution is required to prevent freezing of the evaporator. Freezing may cause the evaporator to rupture allowing water and refrigerant to mix causing severe damage to the refrigeration system which is not covered under warranty.
3. On R22, R134A and R407C models operating above 70°F and R404A models operating above 60°F requires the addition of a refrigerant crankcase pressure regulating (CPR) valve. The CPR valve is necessary to prevent overloading of the compressor which can cause premature failure. R410A models may be operated up to 80°F without a CPR valve.

B. TEMPERATURE INDICATION AND DISPLAY



1. Temperature information is displayed via the three digit display window.
2. **TO:** Illuminates when the **TO PROCESS** water temperature is displayed. **TO** is the default setting of the **TEMPERATURE DISPLAY** window.
3. **FROM:** Illuminates when the **FROM PROCESS** water temperature is selected. **NOTE:** The instrument will revert back to the **TO PROCESS** temperature display after 10 seconds if the **SELECT** key is used to move from the **TO PROCESS** display. **NOTE:** Both TO and FROM lights are on when zone EVA IN and EVA OUT temperatures are displayed. **NOTE:** Both to and from lights are on when zone EVA IN and EVA OUT temperatures are displayed

4. ° C: Illuminates when the ° C (Celsius) temperature display parameter is selected.
5. ° F: Illuminates when the ° F (Fahrenheit) temperature display parameter is selected. °F is the default setting of the instrument.

C. SETUP DISPLAY

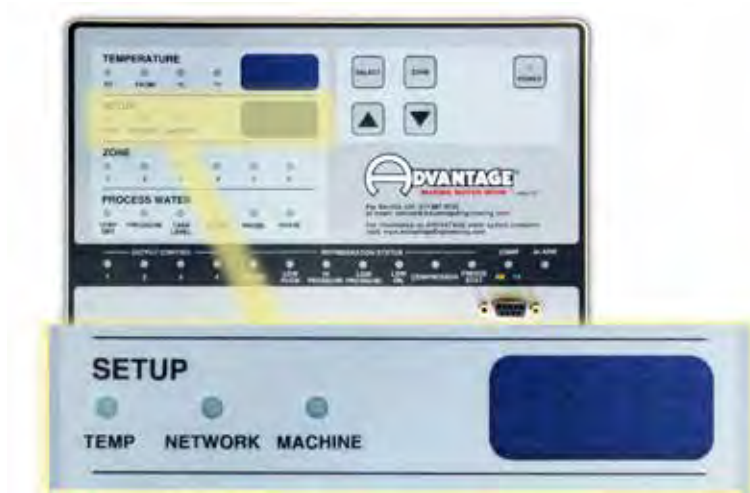

1. When the **SELECT** key is pressed, and the unit is NOT in zone display the display will cycle forward through all available temperature and setup parameters. The currently selected setup parameter is indicated in the **TEMPERATURE** display window (i.e. “Hi” for High Deviation, “Lo” for Low Deviation) and the value is displayed in the **SETUP** display window. Values are changed with the **Up** and **Down** arrows. The available parameters are listed below:

2. Temperature/Setup display sequence:

Temperature Display	Setpoint Display
To	Setpoint
From	Setpoint
‘SP’	Setpoint
‘LE’	Lead Compressor
‘HI’	High Temperature Deviation Limit
‘LO’	Low Temperature Deviation Limit
‘Pro’	Protocol Selection (SPI/CAC)
‘Adr’	Protocol address selection (1-99 / 0-9)
‘rAt’	Protocol baud rate selection (1200-9600)
‘Unt’	Temperature units selection (° F/° C)

3. **TEMP:** Illuminates when the following parameters are selected:

To	To Process Temperature
From	From Process Temperature
SP	Setpoint Temperature
HI	High Temperature Deviation Limit
Lo	Low Temperature Deviation Limit

- a. When the instrument is in the TO, FROM or SP temperature display, the operator may adjust the setpoint temperature with the UP/DOWN arrow keys.
- b. **SP:** Programs the process setpoint. It can be set to a range of 70° - 48° or 90°- 10° depending on the state of SW-1, referenced in the switch description section.
- c. **HI:** Programs the high alarm temperature deviation limit. This is the high temperature setting at which an alarm is activated if the 'to process' temperature reaches it. 1-30 units selectable.
- d. **Lo:** Programs the low alarm temperature deviation limit. This is the low temperature setting at which an alarm is activated if the 'to process' temperature decreases to it. 1-30 units selectable.

3. **NETWORK:** Illuminates when the following parameters are selected:

Pro Protocol selection
Adr Protocol address selection
rAt Protocol baud rate selection

- a. **Pro:** Sets the protocol selection. The protocol is the data format for communications between the unit and the host computer. SPI (standard Society of Plastics Industry) or CAC (standard used on older CMI machines) protocols selectable.
- b. **Adr:** Sets the communication address. This is the number assigned to the unit in a network. 1-99 units selectable in SPI protocol and 0 - 9 in CAMAC protocol.
- c. **rAt:** Programs the baud rate. The baud rate is the data transfer rate between the unit and the host computer. 1200, 2400, 4800, 9600 units selectable.

4. **MACHINE:** Illuminates when the following parameters are selected:

Unt Temperature unit selection
Prb From process probe calibration

- a. **Unt:** Sets temperature display. Select 'F' for Fahrenheit temperature display or select 'C' for Celsius temperature display.
- b. **Prb:** Contact factory for details.

D. ZONE DISPLAY

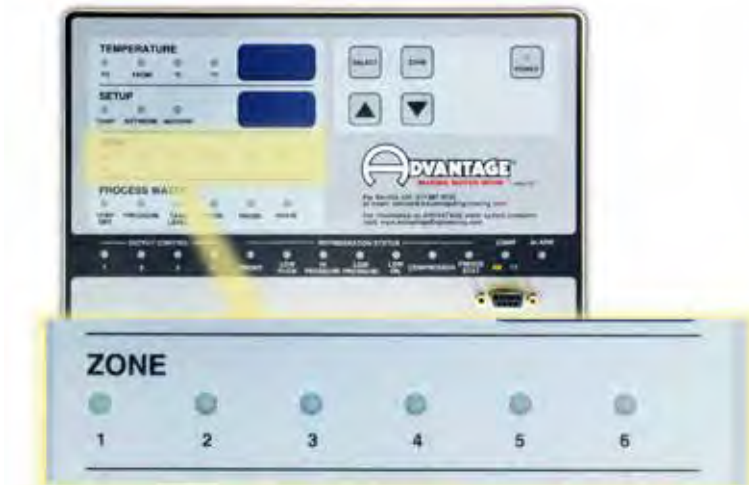

1. The LED's in this section indicate which ZONE is selected for viewing.
2. The status for the selected Zone is displayed in the 'OUTPUT CONTROL' and 'REFRIGERATION STATUS' sections.
3. The operator can select which zone is displayed by using the **ZONE** button. An ON or FLASHING LED indicates the selected zone.

E. PROCESS WATER DISPLAY

- 1.



TEMP DEV: Illuminates according to the current state of temperature deviation:

- a. **SOLID GREEN:** When the process temperature is within the programmed parameters.

- b. **YELLOW:** If the SETPOINT or TO PROCESS temperature different is greater than the programmed HI/LO deviation settings.
 - c. **FLASHING RED:** after about 90 seconds in the YELLOW condition, the LED will display FLASHING RED and the alarm will be sounded. If the difference returns to within acceptable limits before the 90 seconds has elapsed, then the LED will return to GREEN.
- 2. **PRESSURE:** Illuminates according to the current state of process pressure:
 - a. **SOLID GREEN:** The process pressure is within the programmed parameters.
 - b. **FLASHING RED:** The process pressure has deviated out of the programmed parameters.
 - c. **SOLID RED:** The process pressure had once deviated out of the programmed parameters but is now within the programmed parameters.
- 3. **TANK LEVEL:** Illuminates according to the current state of tank level:
 - a. **SOLID GREEN:** The reservoir tank is at proper operating level.
 - b. **FLASHING RED:** The reservoir level has dropped below the proper operating level and the make-up supply system is activated to restore the water level
 - c. **SOLID RED:** The proper operating level has been restored.
- 4. **FLOW:** Does not display flow status at this time.
- 5. **PROBE:** Illuminates according to the current state of the process and zone probes:
 - a. **SOLID GREEN:** The process probes are ok and working fine.
 - b. **FLASHING RED:** One of the process probes is not functioning correctly.
 - c. **SOLID RED:** One of the probes had a fault, but the fault is no longer present.
- 6. **PHASE:** Illuminates according to the current state of electrical phase:
 - a. **SOLID GREEN:** The electrical phase is within the acceptable parameters.
 - b. **FLASHING RED:** Indicates improper phasing of the incoming 3 phase supply.
 - c. **SOLID RED:** The phasing had once been 'in fault' but is now restored.

F. OUTPUT CONTROL SECTION



1. The following LED's are SOLID GREEN when the output is "ON".
2. **COMPRESSOR:** Illuminates when the compressor has cycled on.
3. **CAPACITY 1:** Illuminates when the controller has cycled on the first stage of capacity control, either a hot gas bypass system or a cylinder unloading system, depending on the configuration.
4. **CAPACITY 2:** Illuminates when the controller has cycled on the second stage of capacity control. May not be available, depending on capacity control configuration.
5. **CAPACITY 3:** Illuminates when the controller has cycled on the third stage of capacity control. May not be available, depending on capacity control configuration.

G. REFRIGERATION STATUS SECTION



1. Machine status lights indicate the operating status of several machine components, PER ZONE. Further operational and troubleshooting information for each refrigerant component is located elsewhere in this manual.
2. For each component (listed below):
 - a. **SOLID GREEN:** Indicates the component is currently at an acceptable run condition.
 - b. **FLASHING RED:** Indicates the component is currently at an unacceptable run condition.
 - c. **SOLID RED:** Indicates the component had once been at an unacceptable run condition, but is now at an acceptable run condition. A solid red light can be changed into a solid green light by pressing the 'select' key.
3. **PROBE:** Indicates the status of the zone evaporator temperature probes.
4. **LOW FLOW:** Indicates the status of the zone 'low flow' switch.
5. **HI PRESSURE:** Indicates the status of the refrigerant 'high pressure' safety switch.
6. **LOW PRESSURE:** Indicates the status of the refrigerant 'low pressure' safety switch.
7. **LOW OIL:** Indicates the status of the 'low oil' pressure safety switch. This light activates on models with a 15-30 ton semi-hermetic compressor.
8. **COMPRESSOR:** Indicates the status of the zone compressor motor overload relay.
9. **FREEZESTAT:** Indicates the status of the 'freezestat' safety switch.

H. COMMUNICATION STATUS



1. The communication display indicates the type of (SPI/CAC) exchange between the host computer and the controller.
 - a. **FLASHING GREEN:** Indicates the controller is sending information to the host computer.
 - b. **FLASHING YELLOW:** Indicates the host computer is sending information to the controller.

ALARM status



1. When this light illuminates RED, an unacceptable condition has developed, at which time a 115 volt alarm output is generated for an external (factory or customer installed) alarm beacon or buzzer.
2. Pressing the SELECT or ZONE key can silence the visual and/or audible alarm signal.

J. OPERATOR CONTROLS



1. **SELECT:** Depress this button to index through the 'system/zone' temperature and 'system/zone' parameters.
2. **ZONE:** Depress the button to index through the available refrigerant zone displays. When in the 'zone mode' the zone display LED's will flash. If the SELECT button is pressed while in a zone LED is flashing, the zone parameters will be displayed.

Temperature Display	Setpoint Display
Ei(x)	Evaporator In Temperature
Eo(x)	Evaporator Out Temperature
CF(x)	Configuration (0 - F)
SP(x)	Backup Setpoint (10 - 90)
LP(x)	Low Pressure Time Display (10-120 sec)

3. **UP ARROW:** Depress this push button to increase the parameter displayed in the SETUP window. If this push button is pressed momentarily, the value is incremented by one. If the push button is held down for more than one second, the value will increase slowly at first and then faster after about two seconds.
4. **UP ARROW:** Depress this push button to decrease the parameter displayed in the SETUP window. If this push button is pressed momentarily, the value is decremented by one. If the push button is held down for more than one second, the value will decrease slowly at first and then faster after about two seconds.
5. **Note:** When setting the Low Pressure Delay or Backup Setpoint on the zone boards, press the UP or DOWN buttons to keep the display from timing out and reverting back to the default to PROCESS mode.
6. **POWER:** This LED indicates when the power to the unit is turned on.
7. **POWER ON LED:** Indicates that power is applied to the controller board.

3.5 MZC ZONE BOARD

A. INTRODUCTION

1. The Zone Board is used to interface from the Controller Board to the chiller system compressors, bypass valves and safety switches. Communications with the MZC Controller Board is via an RS-485 network.
2. If communications with the Controller Board fails the Zone Board will switch to a stand-alone mode and maintain control of the system independent of the MZC Controller board based on the value of the Alternate Setpoint Potentiometer.

B. USER CONTROLS

1. ZONE AC POWER SWITCH (Toggle Switch)

'ON': Applies 110VAC power to Safety Switches and AC OUTPUT's

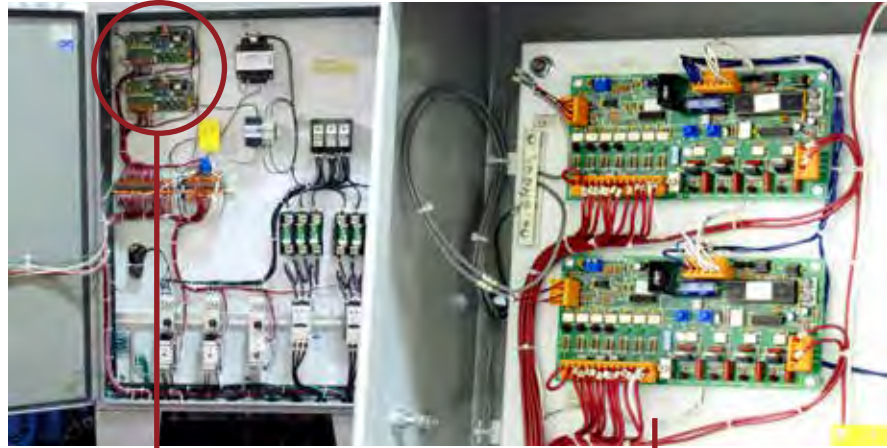

Zone Board location inside electrical cabinet.

Detail of Zone Boards.

'OFF': Disconnects 110VAC power from Safety Switches and ACOUTPUT's

2. ADDRESS SWITCH (Rotary Switch)

Selects address of ZONE Board from 1 to 7, 0 is not used for normal operation

NOTE: Each ZONE BOARD in the system must be set to a different address.

3. CONFIGURATION SWITCH (Rotary Switch)

Selects configuration number from 0 to F

4. LOW PRESSURE TIME DELAY POTENTIOMETER

Adjust value of low-pressure time delay from 10 to 120 seconds.

5. Alternate Setpoint Potentiometer

Adjust value of alternate setpoint from 10 to 90. This setpoint is **ONLY** used when the RS-485 communications with the Controller Board is not working properly.

C. STATUS DISPLAY SECTION

LED displays that indicate the status of the chiller.

- 1. POWER LED:** Indicates that 12VDC power is applied to the Zone Board.

2. SAFETY/PROTECTION LED's

OIL: Low oil pressure safety switch fault.
COMP: Compressor motor overload fault.
HP: Refrigerant high-pressure safety switch fault.
FREEZE: Freezestat safety switch fault.
LF: Low water flow switch fault.
LP: Refrigerant low -pressure safety switch fault
ZONE: Zone Board 110VAC power switch is 'ON'.

3

AC OUTPUT LED's

See Configuration Matrix Chart for description of **OUTPUT LED's**. The state of these **LEDs** should correspond with the **OUTPUT CONTROL LEDs** on the **MZC** Controller Board.

OUT 1: Indicates output status of OUT 1
OUT 2: Indicates output status of OUT 2
OUT 3: Indicates output status of OUT 3
OUT 4: Indicates output status of OUT 4

D. INTERFACE SECTION

1. SAFETY/PROTECTION CONNECTOR

Electrical connections to safety switches.

OIL: Low oil pressure safety switch.
COMP: Compressor motor overload safety switch.
HP: Refrigerant high-pressure safety switch.
FREEZE: Freezestat safety switch.
LF: Low water flow switch fault.
LP: Refrigerant low -pressure safety switch.
ZONE: Zone Board 110 AC power input.

2. AC OUTPUT CONNECTOR

Electrical connections to AC outputs. See Configuration Matrix Chart for description of OUTPUT's.

OUT 1: output 1 AC Connection
OUT 2: output 2 AC Connection
OUT 3: output 3 AC Connection
OUT 4: output 4 AC Connection

3. DC POWER SUPPLY/COMMUNICATIONS CONNECTOR

PWR: 12VDC+
GND: 12VDC GND
GND: 12VDC GND
+: RS-485 + TXS/RXD to Controller Board
-: RS-485 - TXS/RXD to Controller Board
GND: RS-485 GND

4. **INTERFACE SECTION (continued)**

OUT BLK: 12VDC+
OUT WHT: 12VDC GND
IN BLK: 12VDC GND
+: RS-485 + TXS/RXD to Controller Board
-: RS-485 - TXS/RXD to Controller Board
GND: RS-485 GND

5.

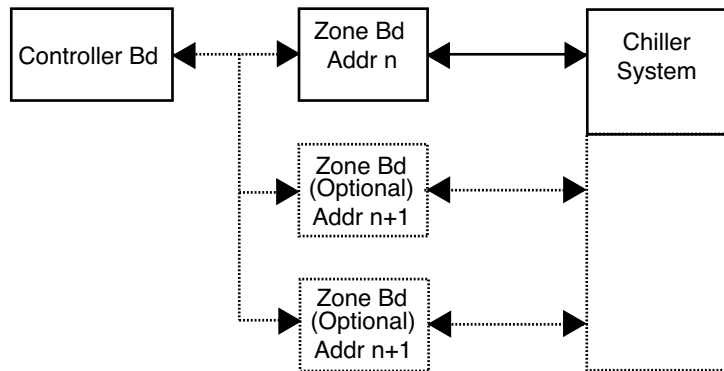

Note: n= 1 to 7

3.5 **CONFIGURATION SWITCH ADJUSTMENT - MZC INSTRUMENT ONLY**

- A. The Configuration Switch for Multizone instruments is located on the Zone board. The Zone board is placed inside the electrical cabinet.
- B. This applies to adjustment of the low ambient controls.
- C. With the power supply to the unit shut off, locate the Configuration switch.
- D. Rotate the switch until the correct number is shown. Select the number according to your machine set up as listed below.



Configuration Matrix Chart : Zone B

Conf. Setting	OUT1	OUT2	OUT3	OUT4
0	COMPRESSOR	UNLOADER	UNLOADER	UNLOADER
1	DIG SCRL COMP	RESERVED	RESERVED	DIG SCRL UNL
2	DIG SCRL COMP	STD COMP	RESERVED	DIG SCRL UNL
3	RESERVED	RESERVED	RESERVED	RESERVED
4	RESERVED	RESERVED	RESERVED	RESERVED
5	RESERVED	RESERVED	RESERVED	RESERVED
6	RESERVED	RESERVED	RESERVED	RESERVED
7	RESERVED	RESERVED	RESERVED	RESERVED
8*	COMPRESSOR	UNLOADER	UNLOADER	UNLOADER
9*	DIG SCRL COMP	RESERVED	RESERVED	DIG SCRL UNL
A*	DIG SCRL COMP	STD COMP	RESERVED	DIG SCRL UNL
B	RESERVED	RESERVED	RESERVED	RESERVED
C	RESERVED	RESERVED	RESERVED	RESERVED
D	RESERVED	RESERVED	RESERVED	RESERVED
E	RESERVED	RESERVED	RESERVED	RESERVED
F	RESERVED	RESERVED	RESERVED	RESERVED

* Allow units with a remote condenser to start in low pressure condition.

Configuration Matrix Chart

Conf. Setting	OUT1	OUT2	OUT3	OUT4
0	COMPRESSOR	RESERVED	RESERVED	HGBP
1	COMPRESSOR	UNLOADER	RESERVED	HGBP
2	COMPRESSOR	UNLOADER	UNLOADER	HGBP
3	COMPRESSOR	UNLOADER	RESERVED	RESERVED
4	COMPRESSOR	UNLOADER	UNLOADER	RESERVED
5	COMPRESSOR	COMPRESSOR	RESERVED	HGBP
6	SCREW COMPRESSOR	SOLENIOD 2	SOLENIOD 3	SOLENIOD 4
7	SCREW COMPRESSOR	SOLENIOD 1	SOLENIOD 2	RESERVED
8*	COMPRESSOR	RESERVED	RESERVED	HGBP
9*	COMPRESSOR	UNLOADER	UNLOADER	HGBP
A*	COMPRESSOR	UNLOADER	RESERVED	HGBP
B*	COMPRESSOR	UNLOADER	UNLOADER	RESERVED
C*	COMPRESSOR	UNLOADER	RESERVED	RESERVED
D*	COMPRESSOR	COMPRESSOR	RESERVED	HGBP
E	SCREW COMPRESSOR	SOLENIOD 2	SOLENIOD 3	SOLENIOD 4
F	SCREW COMPRESSOR	SOLENIOD 1	SOLENIOD2	RESERVED

* Allow units with a remote condenser to start in low ambient/low pressure condition.

3.7 CONTROLS

- A. **Flow switch:** Installed on each evaporator water circuit. Its mission is to monitor the fluid flow and to shut down the compressor in case a harmful low flow condition should develop.
- B. **Freezestat:** Factory adjusted to turn off the compressor in the event an unsafe temperature should exist from the evaporator. This switch should be periodically checked for proper operation.
- C. **High Pressure:** Factory set or fixed cut out, manual or automatic reset required. Opens due to high pressures associated with improper refrigerant condensing or high fluid temperature overloading the compressor.
- D. **Low Pressure:** Factory or fixed cut out and cut-in points based on refrigeration type, automatic reset. Opens due to low pressures associated with improper refrigerant evaporating temperatures.

Before the initial start-up confirm that the low pressure settings are set for the fluid type and fluid temperature. Failure to set the low pressure limit properly can lead to unit freeze up and damage which is not covered by the warranty. See section 3.9 for proper setting and 8.1.H for the proper values based on fluid, refrigerant used in the system and operating temperature.

NEVER LOWER THE CUT OUT SETTING WITHOUT ADDING GLYCOL TO THE CIRCULATING SYSTEM. EVAPORATOR DAMAGE WILL RESULT AND WILL NOT BE COVERED BY THE WARRANTY.

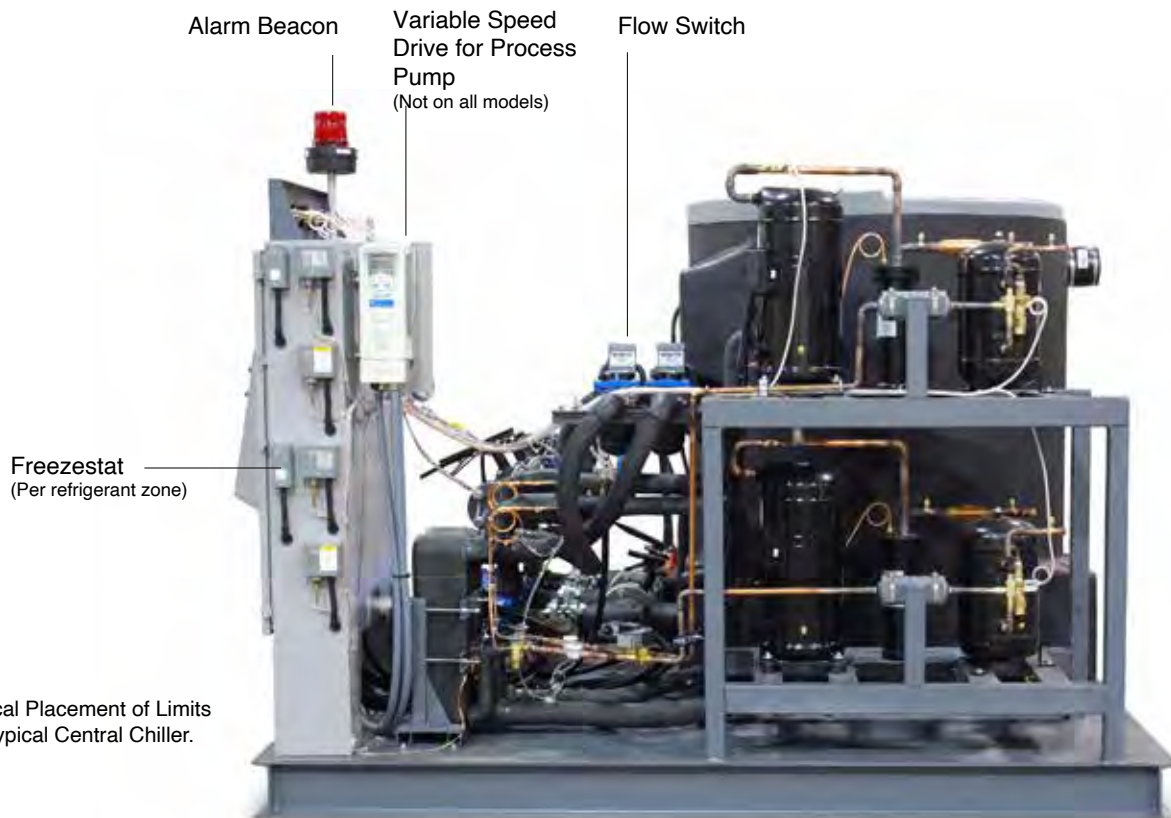

Typical Placement of Limits on Typical Central Chiller.

- E. **Oil pressure safety switch** de-energizes the compressor if oil pressure in the compressor is not adequate. Refer to the troubleshooting guide for common reasons for this failure. (Provided on certain models.)
- F. The **alarm pressure switch** functions to energize the alarm if coolant pressure is denied the process.

3.8 PRESSURE GAUGE & ALARM BEACON

- A. The **to process pressure gauge** indicates fluid pressure being delivered by the process pump to the load.
- B. The **alarm beacon** is visual and audible. The alarm will activate when the water temperature leaving the chiller is too high and when fluid pressure is lost from the process pump. An alarm silence switch is provided to deactivate the alarm while corrective measures are being taken.

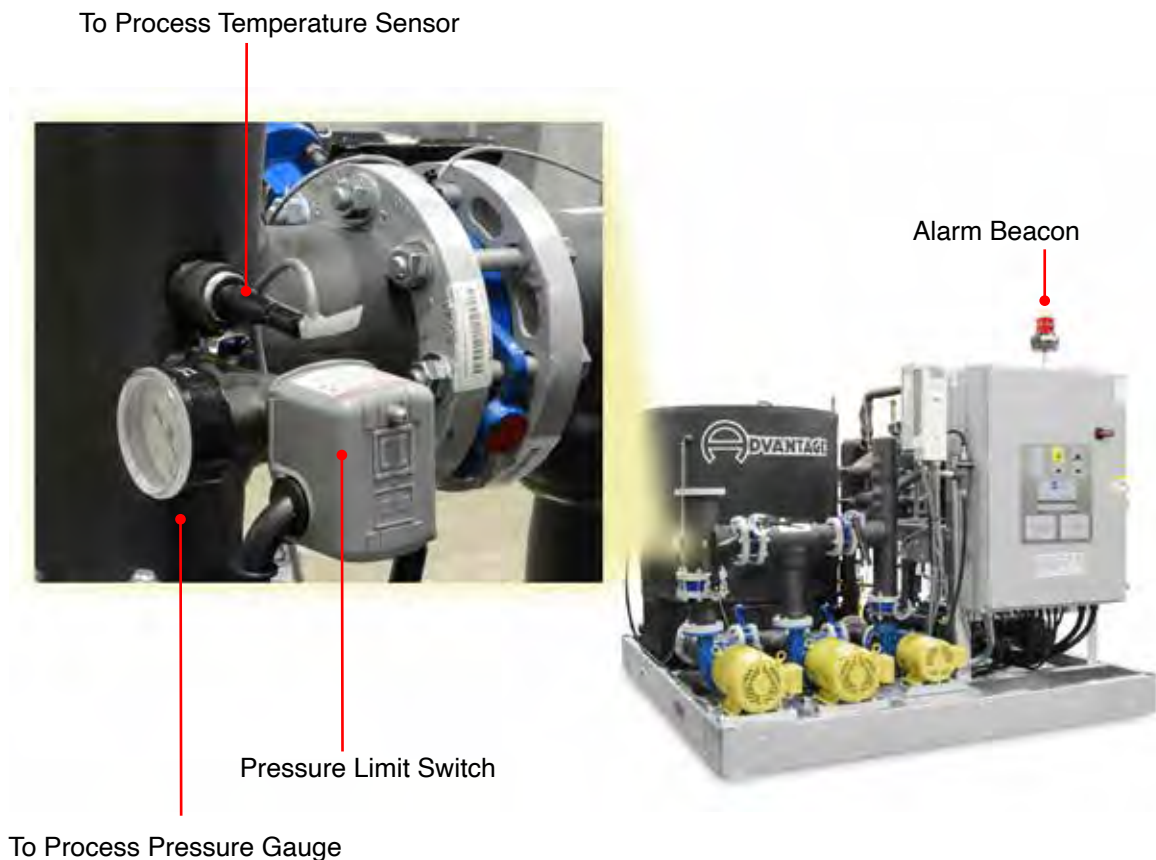

3.9 DIGITAL PRESSURESTAT SET UP

- A.** Most models of this central chiller include digital pressurestats for refrigerant high and low pressure monitoring and display in lieu of traditional analog gauges.
- B.** The digital refrigerant pressurestat is a dual pressure limit switch as well as a current value refrigerant pressure display that uses transducers with a 0-10v output an in input source.
- C.** The digital pressurestat generally comes factory set for systems using water above 48F. Before starting the unit for the first time confirm that the settings are correct. See the chart below for the proper values based on fluid, refrigerant used in the system and operating temperature. Failure to set the low pressure limit properly can lead to unit freeze up and damage which is not covered by the warranty.

Refrigerant Low Pressure Switch Cut-Out & Cut-In Settings

Ambient Temperature	Operating Temperature	Glycol	Freeze Point	Cut Out Temp	Cut In Temp	R22		R134A		R410A	
						Cut-Out	Cut-In	Cut-Out	Cut-In	Cut-Out	Cut-In
39°F +	48° - 70°F	0%	32°F	32°F	36°F - 39°F	58#	63#	28#	33#	102#	111#
15° to 38°F	25° - 47°F	30%	10°F	10°F	15°F - 18°F	33#	38#	12#	17#	63#	72#
0° to 14°F	10° - 24°F	40%	-5°F	-5°F	0°F - 7°F	20#	25#	4#	9#	43#	52#
-10° to 0°F	n/a	45%									
-20° to -10°F	n/a	50%									

Ambient Temperature	Operating Temperature	Glycol	Freeze Point	Cut Out Temp	Cut In Temp	R404A		R407C	
						Cut-Out	Cut-In	Cut-Out	Cut-In
39°F +	48° - 70°F	0%	32°F	32°F	36°F - 39°F	72#	79#	52#	58#
15° to 38°F	25° - 47°F	30%	10°F	10°F	15°F - 18°F	44#	49#	28#	34#
0° to 14°F	10° - 24°F	40%	-5°F	-5°F	0°F - 7°F	29#	34#	16#	22#
-10° to 0°F	n/a	45%							
-20° to -10°F	n/a	50%							

High Pressure Cut Out (maximum) (with liquid receiver)

Refrigerant	Air-Cooled
R22	360#
R134A	260#
R407C	360#
R410A	550#
R404A	360#

- D.** In normal running mode the head pressure and the suction pressure for a single refrigerant zone is continuously displayed. The small arrows along the bottom of the display window indicate that the relay contacts are closed and the system is functional.

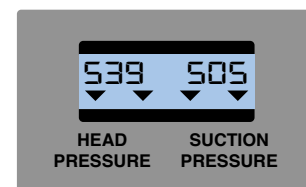

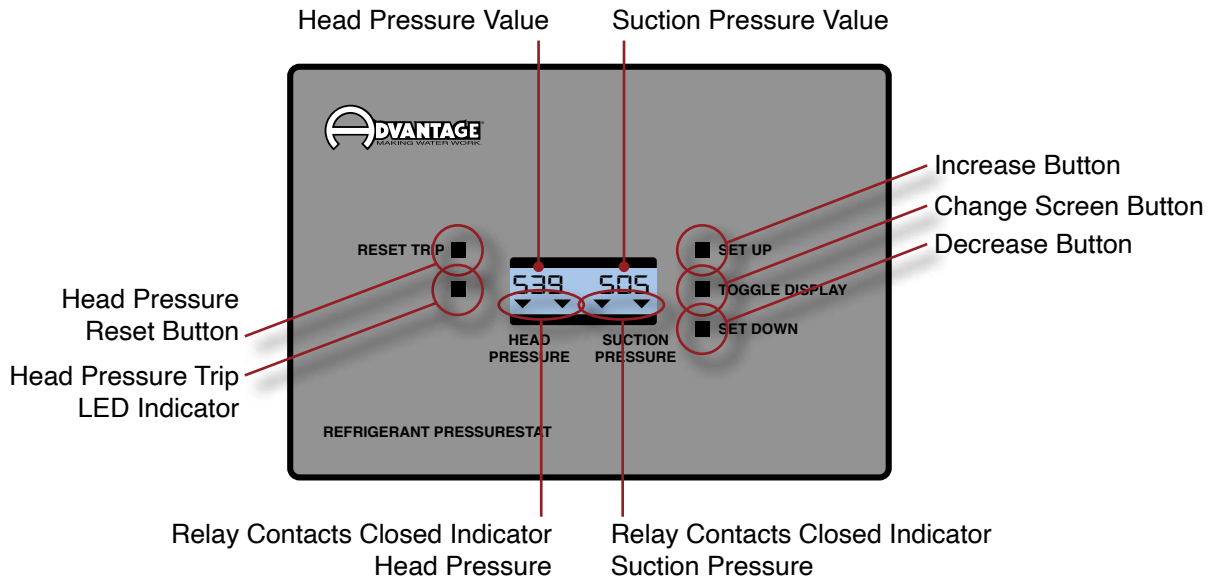

E. When either the head pressure or suction pressure is measured out of the set point range the corresponding arrows will disappear. If the head pressure is out of range the red LED will come on and the reset button will have to be manually pushed after the condition has been corrected.

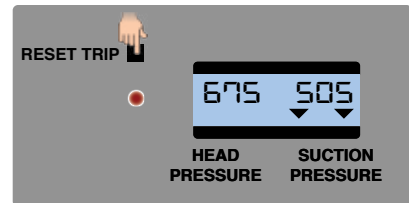

F. If the suction pressure is out of range the system will reactivate automatically after the pressure rises above the differential value.

G. To change set point values :

1. On Initial Start-up press the Reset button to clear any errors.
2. Press and release the Toggle Display button once. You will see **hpSET XXX**. The current set point for head pressure cut out will be in the place of the XXX. Use the Set Up and Set Down buttons to change the value. This value must not be set higher than 50 PSI below the relief device setting.
3. Press and release the Toggle Display button again to save the new setpoint and move to the next value. You will see **spset XXX**, the suction pressure cut out value. Use the Up and Down buttons to adjust

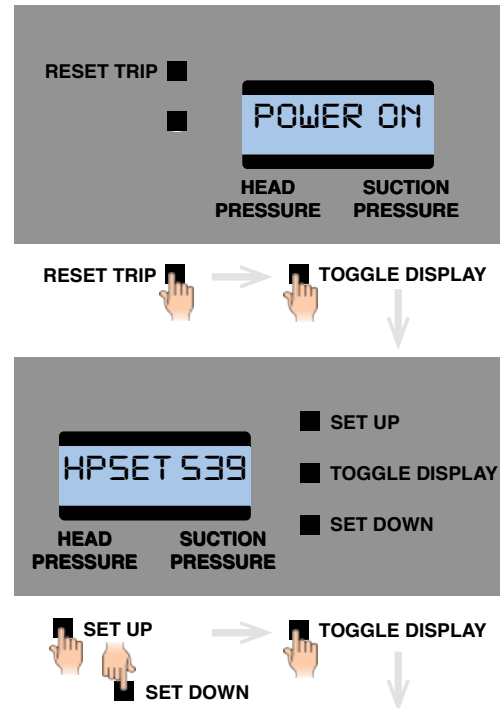

the value. This value must not be set lower than the pressure that corresponds to the freeze point of the fluid being chilled otherwise severe damage to the evaporator could occur.

4. Press and release the Toggle Display button again to save the value and move to the next value.
5. You will see **spDif XXX**, the suction pressure differential. This value indicates the number of PSI the suction pressure must rise above the cut out value before the system will restart. 10 PSI is usually a good number for this value and is the default value.
6. Press the Toggle Display button once more to save the value and return to the display screen.

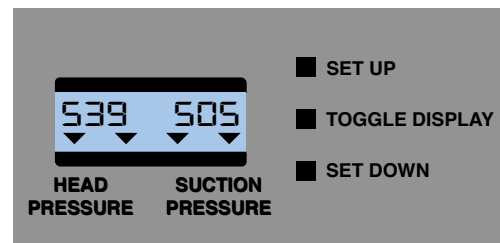
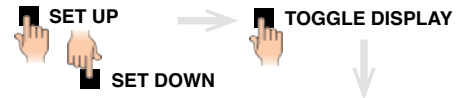
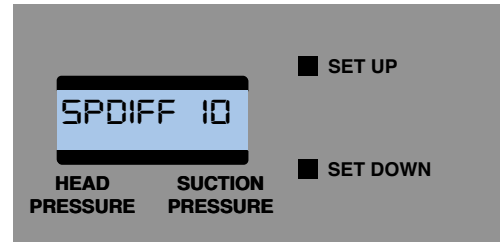
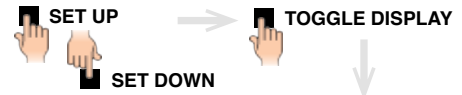
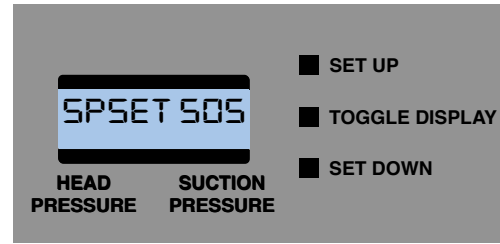

3.10 ZONE LEAD LAG

- A. The Lead zone (refrigeration zone that turns on first) can be selected on models that have two or more zones and that include the MZCIII control instrument.
- B. This feature can be used to equalize run time on zones in the system if desired.
- C. The lead zone is selected as described below.
 - 1. On the MZCIII control press the Select Button until LEA appears in the top LED window.
 - 2. Press the zone button until the Zone LED light for the desired Lead zone is illuminated.
 - 3. The setting must be confirmed in one of these methods.
 - a. The chiller refrigeration zones need to turn off on satisfaction, meaning that no cooling is required so no zones are running. When the zones restart the Lead zone setting that was selected in steps 1 & 2 above will be enabled. This can be accomplished by raising the set point temperature about 10°F which will cause the chiller to quickly reduce cooling capacity and achieve satisfaction. Once all compressors have turned off, the set point can be reduced to the normal value. Do not use this method if a temporary increase in the chilled water temperature will affect your process.
 - b. Or, power the main disconnect off for at least 10 seconds, restart the system and the lead zone selected in steps 1 & 2 above will be enabled.



4.0 TROUBLESHOOTING

- 4.1** Unit Will Not Start
- 4.2** Compressor Hums But Will Not Start
- 4.3** Shuts Off On High Pressure
- 4.4** Shuts Off On Low Pressure
- 4.5** Compressor Shuts Off on Internal Overload
- 4.6** Low or No Process Pressure or Water Flow
- 4.7** Cooling Capacity Inadequate
- 4.8** Sensor
- 4.9** Pumps
- 4.10** Chiller Controller



WARNING: Before troubleshooting or servicing this unit, follow all company lock-out tag-out procedures.

4.1 UNIT WILL NOT START

- A. **Power off.** Check main disconnect.
- B. **Main line open.** Check fuses.
- C. **Loose terminals.** Tighten terminals with POWER OFF.
- D. **Control circuit open.** Check control voltage fuses and transformer.

4.2 COMPRESSOR HUMS BUT WILL NOT START

- A. **Contactor problem.** Check contacts and contactor operation.
- B. **Low voltage.** Check voltage at main and at the unit. If voltage is OK at the main but low at the unit, increase wire size. If low at main, consult your local power company. Voltage must be +/- 10% nameplate rating.
- C. **No power on one phase of a three phase unit.** Check fuses in control panel and main disconnect. Also check unit wiring, main plant fuse and wiring. If the problem is with the main power supply coming into the plant, call the local power company.
- D. **Loose terminals.** Power off and follow all company lock-out tag-out procedure before tightening terminals.

4.3 SHUTS OFF ON HIGH PRESSURE LIMIT

Note: Units may be equipped with either an adjustable or non-adjustable “fixed” high pressure switch or a digital pressurestat described in section 3.9. If the refrigerant pressure exceeds the setting of the adjustable switch it must be manually reset when the discharge pressure falls to a safe level. The non-adjustable “fixed” high pressure switch will automatically reset when the discharge pressure falls to a safe level.



Adjustable High Pressure Switch

A. Air-cooled units:

1. **Insufficient condenser air flow.** Check condenser filter for dirt, fins may be plugged with dirt or foreign material. Also, check for proper fan rotation.



Fixed High Pressure Switch

Note: All enclosure panels on the air-cooled condenser must be attached.

2. **Fan motor not operating.** Have electrician check fuses and wiring, motor starter and overloads, and motor. Repair or replace motor if defective.

B. Water-cooled units:

* See Temperature-Pressure chart in Section 8.2 for refrigerant pressure.

1. **Water regulator valve.** Adjust condenser water regulator valve to maintain 100°F to 105°F refrigerant condensing temperature*. If valve is defective, have valve repaired or replaced by a refrigeration serviceman.
2. The water regulator valve is normally factory set for proper operation. When field adjustments are required, turn the adjusting nut on the top of the valve counter clockwise to raise the refrigerant pressure and clockwise to lower the pressure. Adjustments should be made only when the chiller is running at full load.
3. **Insufficient condenser water flow.** Check condenser water pumping system.
4. **Condenser water temperature too high.** Check cooling tower for proper operation if used and the city water temperature if city water is used.
5. **Condenser water tubes scaled.** Clean with brushes and chemicals approved by the Advantage Service Department.

- C. Improperly set high pressure control.** Have refrigeration serviceman reset or replace the control if defective.

4.4 SHUTS OFF ON LOW PRESSURE CONTROL

Note: Units may be equipped with either an adjustable or non-adjustable “fixed” low pressure switch or a digital pressurestat described in section 3.9. The adjustable or fixed low pressure switch will automatically resets when the pressure rises above the cut-in pressure. If this does not occur contact the Manufacturer’s service department for instructions.



Adjustable Low Pressure Switch

If the unit low pressure limit activated three (3) consecutive times during start-up the unit will lock out and will not be allowed to start. To r... must be powered down and back on.

* See Temperature-Pressure chart in Section 8.2 for refrigerant pressure.

For refrigerant R410A and when using water with a setpoint of 48F or higher, the low pressure switch is set to cut-out at 32°F and cut-in at 36°F - 39°F*. See section 8.1.H for settings for other refrigerants, fluids and set point values. If a low pressure condition exists for more than five seconds the compressor will stop and a “L-P” fault will appear in the display window.



Fixed Low Pressure Switch

After the refrigerant pressure rises above the cut-in pressure, a three minute time delay will occur before the compressor restarts. This will protect the evaporator and compressor from damage should a problem occur in the refrigeration system or if the chiller is operated under circumstances which could cause damage to the refrigeration system.

A. Air-cooled units:

* See Temperature-Pressure chart in Section 8.2 for refrigerant pressure.

Head pressure too low.

1. Check fan pressure settings on outdoor remote condenser. Contact factor for proper settings.

B. Water-cooled units:

1. **Head pressure too low.** Adjust condenser water regulating valve to maintain 100°F - 105°F refrigerant condensing temperature*. Have a refrigeration serviceman repair the valve or replace if defective.
2. The water regulator valve is normally factory set for proper operation. When field adjustments are required, turn the adjusting nut on the top of the valve counter clockwise to raise the refrigerant pressure and clockwise to lower the pressure. Adjustments should be made only when the chiller is running at full load.

- C. Low refrigerant charge.** Check for adequate refrigerant charge (bubbles or misty sight glass indicates low charge). If charge is low, have system checked for leaks and recharged by a refrigeration serviceman.

- D. Improperly set low pressure switch.** Have a refrigeration serviceman reset control or replace if defective.

E. Restriction in the liquid line.

1. **Clogged filter drier.** Check for pressure or temperature drop and have drier core replaced by a refrigeration serviceman.
2. **Liquid line valve or suction valve on compressor is partially closed.** Open fully.
3. **Liquid line solenoid not opening fully or leaking during off cycle.** Have the solenoid repaired or replaced if defective by a refrigeration serviceman.
4. **Expansion valve plugged or inoperative.** Check thermal bulb and capillary tube for damage. Have repaired or replaced if defective by a refrigeration service man.

F. Low or no fluid flow through evaporators

- 1 Check pump for proper flow.
2. Check basket strainers (if present) on inlet to evaporators for debris. Clean if dirty.

4.5 COMPRESSOR SHUTS OFF ON INTERNAL OVERLOAD

- A. Control does not reset.** Have compressor windings and internal solid state safety control checked by a refrigeration serviceman. Have it repaired or replace if defective.

4.6 LOW OR NO PROCESS PRESSURE OR WATER FLOW

- A. **Valves.** Check if water valves are open.
- B. **Pump.** Check pump for correct rotation. Check pump suction for restriction. Replace motor if defective.
- C. **Filters.** Check filter in the chilled water circuit and clean if necessary.
- D. **Pressure switch (or flow switch).** Readjust or replace if defective.
- E. **Fuses and wiring.** Have electrician check the fuses and wiring.

4.7 COOLING CAPACITY INADEQUATE

- A. **Low refrigerant charge.** Check for adequate refrigerant charge (bubbles or misty sight glass indicates low charge). If charge is low, have system checked for leaks and recharged by a refrigeration serviceman.
- B. **Hot-gas bypass valve stuck open.** Have repaired or replace if defective by a refrigeration serviceman.
- C. **Expansion valve plugged or inoperative.** Check thermal bulb and capillary tube for damage. Have repaired or replaced if defective by a refrigeration serviceman.
- D. **Plugged filter.** Check filter in chilled water circuit and clean.
- E. **Air in system.** Purge air.



Typical chilled water sensor probe with 2 pole connector.

4.8 SENSOR

- A. The sensor is a solid state temperature transducer which converts temperature input to proportional current output.
- B. To quickly test for a defective probe, switch connections between the defective probe and a probe known to be working properly. A defective sensor will display a “---” in the display window on the instrument control. Please note that “---” will also display when process temperatures are above 100°F.

4.9 COOLANT PUMP (process, evaporator and standby)

- A. The centrifugal pump is designed to operate at a specific flow and pressure at the maximum run load amp draw of the motor. Too much flow can overload the motor and cause the overload circuit to open and stop the pump.
- B. If the overload trips, check for electrical shorts, loose wires, or blown fuses. If these check

OK, reset the overload circuit and restart the chiller.

4.10 CHILLER CONTROLLER

- A. The control instrument is used for all normal set ups, diagnostics, temperature readout and operational information. It contains the software and electronic components which operate the control instrument.
- B. The control instrument is not field repairable. It can be easily removed and replaced or repaired if a problem occurs.
- C. All control instruments used in Advantage water chillers are covered by the machine's warranty. Proprietary "tailor made" instrument are manufactured specifically for Advantage by our affiliated company Advantage Electronics.

If you experience problems with your Advantage control instrument, it's as easy as 1-2-3 to execute our repair or replacement system in order to get your Advantage equipment running.

D. IN WARRANTY SERVICE INCIDENT

- 1. Call Advantage Service at 317-887-0729 for diagnostic assistance.
- 2. If a control instrument is determined to be at fault, a new or reconditioned instrument will be sent as a replacement.
- 3. Return the defective instrument freight pre-paid for a full credit. If the faulty instrument is not returned you will need to pay for it.

E. OUT-OF-WARRANTY SERVICE INCIDENT

- 1. Call Advantage Service at 317-887-0729 for diagnostic assistance.
- 2. If a control instrument is determined to be at fault there are 3 options:
 - a. Purchase a new instrument as a replacement.
 - b. Send your instrument back for repair, freight prepaid. For a nominal fee (contact factory for current fees) your instrument will be repaired and returned.
 - c. Purchase a new instrument and repair the old one as a back up.
- 3. If you are sending your instrument back for repair **include this form in the box.** Do not disassemble the instrument.

F. OTHER INFORMATION

- 1. Repair Warranty: 1 year.



2. **Ship to: Advantage Engineering 525 East Stop 18 Road Greenwood, IN 46143 Attention: Repairs. (317-887-0729)**
3. Include in box: part, purchase order, contact name, phone number, symptom (if available).
4. For Priority Service, send the instrument to us via overnight shipment.



THIS PAGE INTENTIONALLY BLANK

5.0 MAINTENANCE

- 5.1** Warranty Service Procedure
- 5.2** Periodic Preventive Maintenance
- 5.3** Special Maintenance
- 5.4** Solenoid Valve Service
- 5.5** Pump Seal Service
- 5.6** Checking the Refrigerant Charge
- 5.7** Proper Cleaning Procedure for Brazed Plate Evaporator

5.1 WARRANTY SERVICE PROCEDURE

- A. In the event of a problem with a chiller that can not be resolved by normal troubleshooting procedures, the customer is invited to consult the Service Department for assistance. The correct model number and serial number of the chiller must be available. The service department will attempt to isolate the problem and advise repair procedures. Often times, with the customer's input and with the machine diagnostics, problems can be determined with "over-the-phone" consultation.
- B. If the problem is beyond the scope of "over-the-phone" consultation, and if the warranty status of the machine is valid, the Manufacturer will contact the nearest authorized service contractor and provide authorization to conduct an "on-site" inspection of the unit in order to determine the course of repair. If the chiller is not covered by the warranty, the Manufacturer will advise on the repair and recommend available service contractors.
- C. It is of the utmost importance that you provide the correct model number and serial number of the machine in question. This will allow the Service Department to obtain the correct manufacturing records which will help to properly troubleshoot the problem and obtain the proper replacement parts when they are required. This information is stamped on the data tag that is attached to the electrical enclosure of each machine.
- D. The Service Department must be notified prior to any repair or service of a warranty nature. Warranty claims will not be honored without prior authorization.

5.2 PERIODIC PREVENTATIVE MAINTENANCE

- A. Lubricate all motors. Note that some motors are supplied with sealed bearings.
- B. Tighten all wire terminals.
- C. Clean and check motor starter and contactor contacts.
- D. Check safety switch settings.
- E. Clean condenser fins of dust and dirt (air cooled models only).
- F. Back flush evaporator.
- G. Check glycol/water solution ratio for operating temperature.
- H. Check system for leaks.
- I. Refrigerant sight glass: Check for bubbles when compressor is operating at 100%. Check the moisture indicator for a color other than green.
- J. Clean unit.

5.3 SPECIAL MAINTENANCE

- A.** Any service of the refrigeration system must be accomplished by a certified refrigeration technician.
1. Addition of compressor oil.
 2. Addition of refrigerant.
 3. Repair of a refrigerant leak.
 4. Adjustment of super heat.
 5. Changing of filter-drier or drier core.
 6. Repair of a refrigeration solenoid.

5.4 AUTOMATIC WATER MAKE-UP SYSTEM SERVICE

- A. The automatic water make-up system consists of a level switch and a solenoid valve. When the tank level is low the level switch signals the solenoid valve to open allowing make-up water to re-fill the tank.
- B. Level switch maintenance and service.
 - 1. The level switch contacts engage and disengage the water make-up solenoid valve.
 - 2. Poor water quality can allow debris or a film build-up on the level switch contacts which can impair operation. Clean the contacts on a regular basis. If cleaning the contacts does not remedy the problem the level switch must be replaced.

C. Make-up solenoid valve service.

- 1. The make-up solenoid valve may require service for a failed coil or more often it will not fully close because debris from poor make-up water quality is in the valve mechanism.
- 2. To replace the coil, disengage power from the unit following all lock-out tag-out procedures. Remove the wires from the failed coil and remove the coil from the valve stem. Install the new coil on the stem and reconnect the wires.
- 3. To service the solenoid valve follow the procedure below.
 - a. Disengage process operations according to the procedure outlined in **section 3.4**. Be certain process fluid pressure is relieved (coolant pressure gauge reads "0") and water system flow is shut off.
 - b. Disengage main power supply. The operator must follow all lockout/tagout procedures.
 - c. Remove or open any access cover panel and set aside to gain access to the make-up solenoid valve.
 - d. The solenoid valve can be disassemble by removing the 4 retaining screws.
 - e. Keeping all electrical connections intact, lift the coil and top solenoid base assembly and set aside.
 - f. **Note the arrangement of the core spring and core assembly, diaphragm spring and diaphragm assembly. (See diagram.)**
 - g. Clean all components as required.



Typical water make-up.

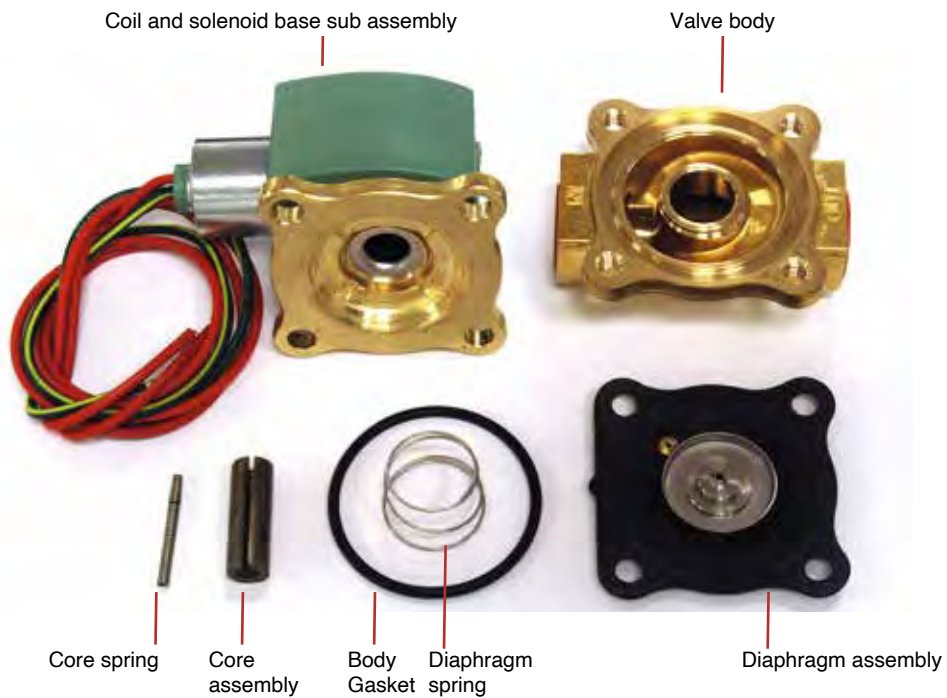
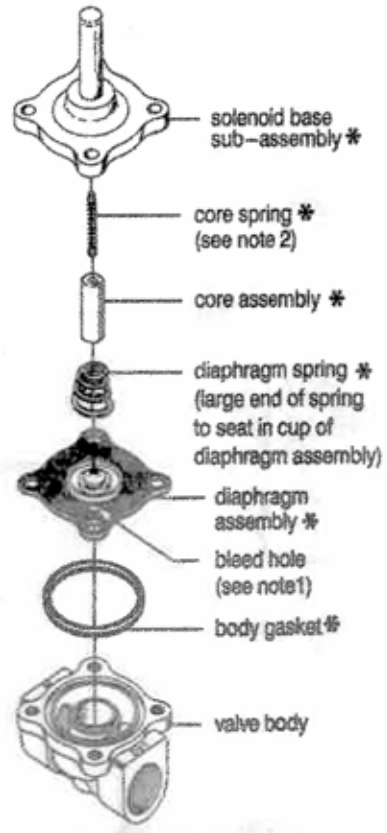

5.5 PUMP SEAL SERVICE

A. The coolant pump seal is a carbon/niresist shaft seal assembly including a stationary member, rotating member and tension spring (figure 5.5A).

B. The operator can determine the pump seal is leaking when fluid is identified leaking from the pump case adapter. Generally, a pump seal will leak due to inadequate unit pressure, excessive flow and poor fluid quality.

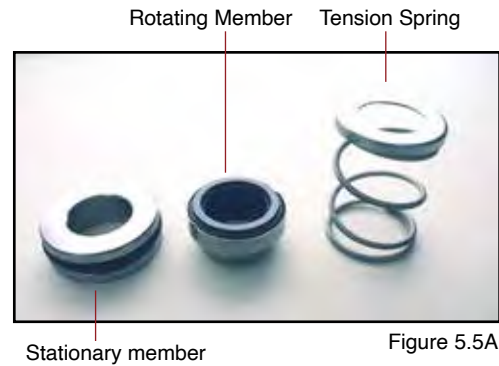

C. The operator should follow this procedure to replace the pump seal:

1. Disengage process operations according to the procedure outlined in **section 3.4**. The operator must be certain process fluid temperature is under 100°F and pressure is relieved (COOLANT pressure gauge reads "0") and water make-up flow is shut off and all pressure relieved.
2. Disengage main power supply. The operator must verify the proper lockout procedures are followed.
3. Access the pump motor by opening or removing any cover panels as necessary (figure 5.5B).
4. Drain machine. The machine can be drained by using the drain valve located on the pump case. Drain fluid into a suitable container for reuse or disposal according to manufacturer's instructions (if a glycol solution is used).
5. Locate and remove the three motor wire leads from the motor wiring terminals. The operator should "map" the wire terminal locations to ensure correct rewiring. The power cord should be removed from the motor housing (figure 5.5C).
6. Locate and remove the pump casing bolts. These bolts secure the motor and motor adapter to the pump casing (figure 5.5D).



Pump motor

Figure 5.5B



Pump motor

Figure 5.5C



Typical pump casing bolt

Figure 5.5D

7. Separate the motor and motor adapter from the pump casing to expose the pump impeller (figure 5.5E). Remove the motor and motor adapter from the unit and place on a workbench to continue the procedure.
8. Locate and remove the dust cap from motor end to expose slotted motor shaft. The motor shaft is free to rotate, but must be secured to remove the impeller. To secure the motor shaft, insert a flat bladed screw driver in slot to hold the shaft stationary (Figure 5.5F).
9. Locate and remove impeller locking screw (Figure 5.5G). Using a socket and ratchet, the impeller retaining screw can be removed. Once the retaining screw is removed, the impeller can be “unthreaded” from the motor shaft to expose the pump seal assembly.
10. Remove all seal parts (Figure 5.5H). Note seal component arrangement to facilitate reassembly.
11. Clean motor shaft and lubricate with a mild soap solution.
12. Install new stationary seal member in pump casing cavity (figure 5.5I). The operator must be certain the stationary seal member is fully squared and seated in cavity.
13. Slide the rotating member onto lubricated pump shaft (figure 5.5J). The operator must be certain not to damage or tear rubber bellows assembly.
14. Place the spring onto the rotating member.
15. Align the impeller, spring and rotating member before reinstalling the impeller (figure 5.5K). The operator must be certain the spring and rotating member are aligned before the impeller is fully tighten and the impeller retaining screw is reinstalled.



Impeller

Figure 5.5E

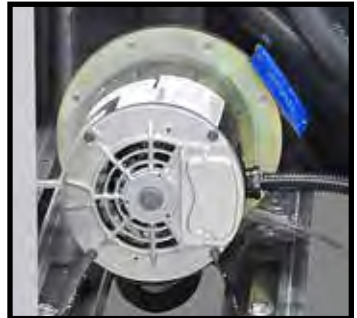

Motor shaft

Figure 5.5F



Typical impeller

Figure 5.5G



Seal components

Figure 5.5H

16. Clean pump casing, cavities, impeller and O-ring before reassembly.
 17. Mate the motor and motor adapter to the pump casing. Reinstall the pump casing bolts.
 18. Reconnect the motor power cord and leads.
 19. Restore all cover panels as were removed.
- E. When the pump seal replacement procedure is complete, the operator may restart the unit according the **section 3**.



Stationary member Figure 5.5I



Stationary member Figure 5.5J

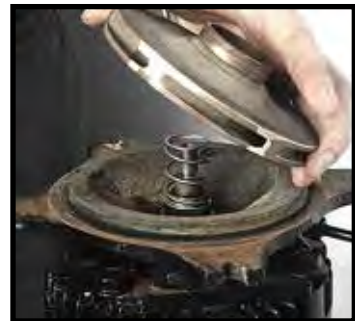

Seal members Figure 5.5K

5.6 CHECKING THE REFRIGERANT CHARGE

- A.** All standard chillers are manufactured with thermostatic expansion valves as the metering device to the evaporator.
- B.** All standard chillers have a refrigerant sight glass with a moisture indicator. To check the refrigerant charge under normal operating conditions:
1. Remove the plastic cap covering the sight glass.
 2. Start the chiller and allow system pressures and temperatures to stabilize.
 3. With the unit operating at 100% capacity (not in the “capacity control” mode) the sight glass should appear clear with no foam or bubbles evident. If foam or bubbles are evident, the chiller has suffered from a loss of refrigerant and should be checked by a qualified refrigeration technician.
 4. The “dot” in the middle of the sight glass is the moisture indicator. It should appear green at all times. A white or yellow color indicates moisture has invaded the refrigeration system, which is detrimental to the life of the compressor. The filter-drier should be replaced by a qualified refrigeration technician.



Refrigerant Sight Glass

5.7 PROPER CLEANING PROCEDURE FOR BRAZED PLATE EVAPORATORS

- A.** The brazed plate evaporator is made of stamped stainless steel plates, furnace brazed together with copper based joints. The complex geometry of the flow passages promotes turbulent flow which gives high efficiency and reduces fouling by mineral deposits. Large solids such as plastic pellets or chunks of mineral deposits will collect at the water inlet port at the evaporator and restrict flow through some of the passages. If this possibility exists, the Manufacturer recommends filters or strainers be added to the “from process” line. If the evaporator becomes fouled there are a couple of methods for cleaning.
- B.** To begin, remove the piping to the “water in” port at the evaporator. Remove any solids that have collected at this point. Then back flush the evaporator to remove any solids that may be trapped between the plates (see back flush procedure below). If there are mineral deposits adhered to the plates, the evaporator must be back flushed with a mild acid solution (5% phosphoric or 5% oxalic acid is recommended.) After cleaning rinse with clear water before returning to service. Continue with step C on the next page.
- C. Back flushing procedure:**
1. Turn off all power to the machine. For chillers with a reservoir tank, drain the tank to below the evaporator outlet. For chillers without a reservoir tank, drain total



Brazed Plate Evaporator

unit.

2. Connect a water supply hose to the evaporator water outlet. If acid cleaning, connect the discharge hose from the acid pump to the evaporator outlet port.
3. Connect a hose to the evaporator water supply port and to an appropriate containment vessel. If acid cleaning, connect the evaporator water inlet port to an acid solution reservoir tank. Dispose of all back flush fluid according to local codes.
4. The cleaning fluid source should have at least 20 psi available. If acid cleaning, follow the instructions supplied with the acid solution carefully.
5. When the procedure is complete, reinstall all water lines to original factory orientation. Restart the unit and check for proper operation.
6. **Note:** This procedure is not normal maintenance. Maintaining proper water quality and filtration will minimize the need to back flush the evaporator.

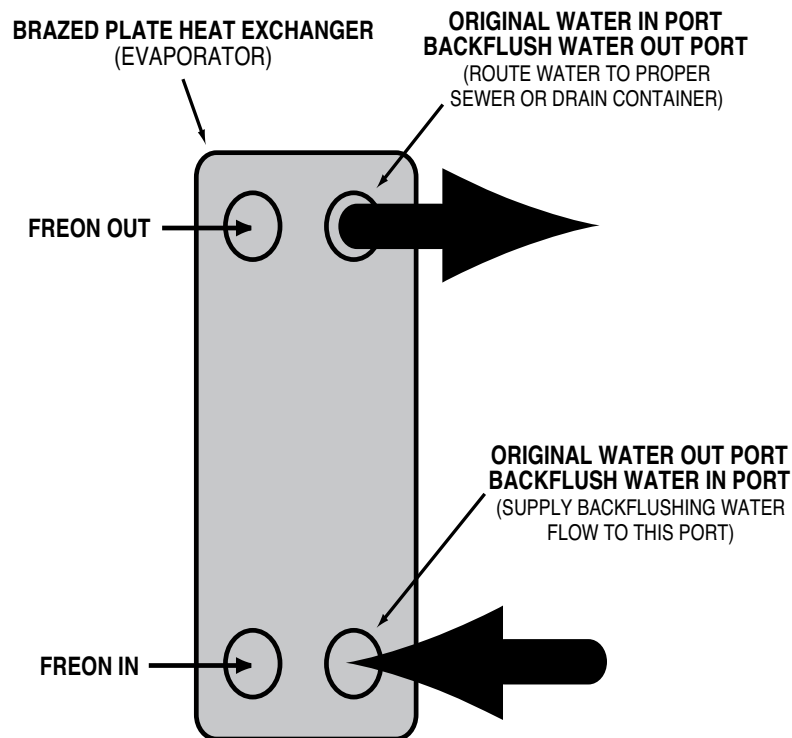

6.0 COMPONENTS

6.1 Refrigeration System

6.2 Coolant System

6.1 REFRIGERATION SYSTEM

- A. COMPRESSOR:** Hermetic or semi-hermetic compressors take low pressure/low temperature refrigerant gas and compress the gas into high pressure/high temperature gas.
- B. AIR-COOLED CONDENSER:** The air cooled condenser removes BTU's from the compressed refrigerant gas. The action causes the gas to "condense" into a liquid state still under high pressure. Air flow across the condenser is achieved via a motor driven fan assembly. The air-cooled condenser is located outdoors on most Titan central chillers. Models using air-cooled condensers are designated with a TI-A in the model number.
- C. WATER-COOLED CONDENSER:** The water cooled condenser removes BTU's from the compressed refrigerant gas. The action causes the gas to "condense" into a liquid state still under high pressure. Water flow across the condenser is provided by an external source, typically the plant's tower water. In some cases, city water is used also. Models using water-cooled condensers are designated with a TI-W in the model number.
- C. FILTER-DRIER:** The filter-drier removes contaminants and moisture from the liquid refrigerant (figure 6.2C).
- D. LIQUID LINE SOLENOID VALVE:** Controlled by the instrument, this valve closes when the compressor cycles off to prevent refrigerant liquid from migrating to the evaporator. The valve opens when the compressor cycles on.
- E. REFRIGERANT SIGHT GLASS:** The refrigerant sight glass indicates refrigerant charge and moisture content. Refrigerant charge is determined by a clear liquid flow. Bubbles indicate low refrigerant. Moisture content is indicated by the color of the element. Element color is normally green. If the color of the element is chartreuse or yellow, the system has been contaminated with moisture. In such case, the filter-drier must be replaced. The replacement of the filter-drier must be completed by a qualified refrigerant service technician.
- F. EXPANSION VALVE:** The expansion valve throttles flow of refrigerant liquid into the evaporator and creates a pressure drop in the refrigerant system that allows the liquid refrigerant to "boil off" inside the evaporator.
- G. EVAPORATOR:** The evaporator is a brazed plate heat exchanger where the refrigerant liquid is allowed to evaporate (boil off) to absorb heat (BTU) from the process fluid. As the heat is absorbed, the process fluid is chilled.



Compressors. Configuration may be different on specific units.



Air-cooled condenser. Typical unit shown.



Water-cooled condenser. Configuration may be different on specific units.

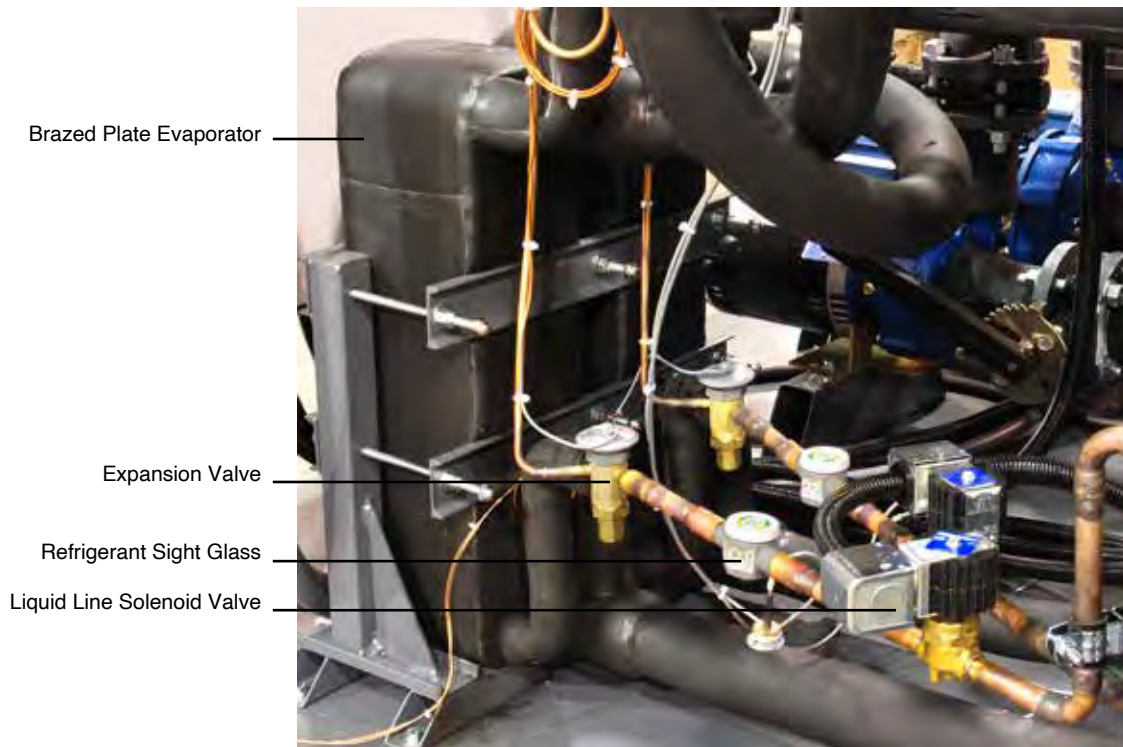

H. HOT GAS BY-PASS SOLENOID: The hot gas by-pass solenoid (Not on all models) prevents short cycling of the compressor by reducing the capacity by 50% when the process fluid temperature nears the setpoint. Some models use digital scroll compressors for capacity control. Screw compressors use step unloaders for capacity control.

I. HIGH/LOW PRESSURESTATS or DIGITAL PRESSURESTAT: the high/low pressurestats protect the refrigeration system from unsafe operating levels.



Adjustable high pressure switch

The **high pressure switch** protects the refrigeration components and personnel from potential damage of injury from excessive high pressure. The high pressure safety must not be altered in the field for any reason. (See section 8.1 for factory settings.)



Adjustable low pressure switch

The **low pressure switch** should be set to open at 32°F and to close at 36° - 39°F when operating with water at 48F or higher. Always confirm proper low pressure settings before initial start-up of the chiller. The low pressure switch protects the chillers from possible damage due to low operating pressure. The low pressure switch is field adjustable for setpoints below 48°F.

NEVER LOWER THE CUT OUT SETTING WITHOUT ADDING GLYCOL TO THE CIRCULATING SYSTEM. EVAPORATOR DAMAGE WILL RESULT AND WILL NOT BE COVERED BY THE WARRANTY.



Digital pressure transducer

* See Temperature-Pressure chart in Section 8.5 for refrigerant pressure.

- J. **Liquid receiver:** Located after the air-cooled condenser, this component receives and stores liquid refrigerant leaving the condenser. (Air-cooled models only).
- K. **Service valves:** Have been provided throughout the system. Only a qualified refrigeration service technician shall operate these valves.

6.2 COOLANT SYSTEM

- A. **Reservoir:** Provides coolant storage during non operating periods. An internal baffle separates 'from process' and 'to process' fluid flows during operating periods.
- B. **Process Pump:** Provides fluid to the central system.
- C. **Standby Pump:** Optional pump to provide backup for the process or evaporator pump.
- D. **Evaporator pump:** Provides consistent flow through the brazed plate evaporators to maintain full capacity.
- E. **Flow switch:** Protects the evaporator from possible freezing caused by too little flow.
- F. **Freezestat:** Protects the system from potential freezing. Factory adjusted to 40°F for operating temperatures above 48°F.
- G. **Level control switch:** Controls water level by activating a solenoid valve (make-up solenoid) which allows water to enter the system from the water supply line.
- H. **Water saver (regulator) valve:** modulates water into the condenser based on refrigerant head pressure. Used on water cooled models only.

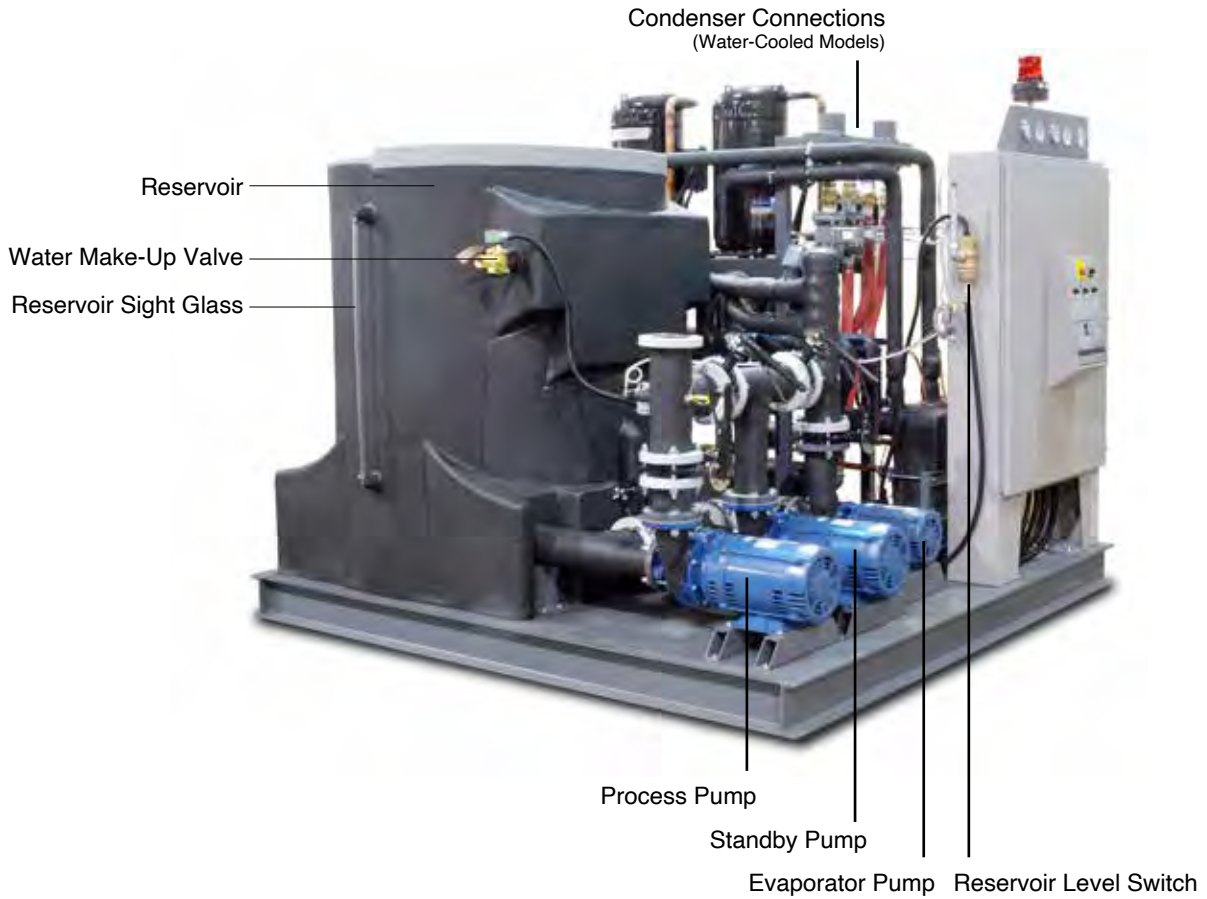

THIS PAGE INTENTIONALLY BLANK

7.0 RELATED DRAWINGS

- 7.1 Circuit Drawing
- 7.2 Typical Press Drop
- 7.3 Typical Vacuum Breaker / Anti-Siphon System



7.1 TITAN CIRCUIT DRAWING (WATER-COOLED MODELS)

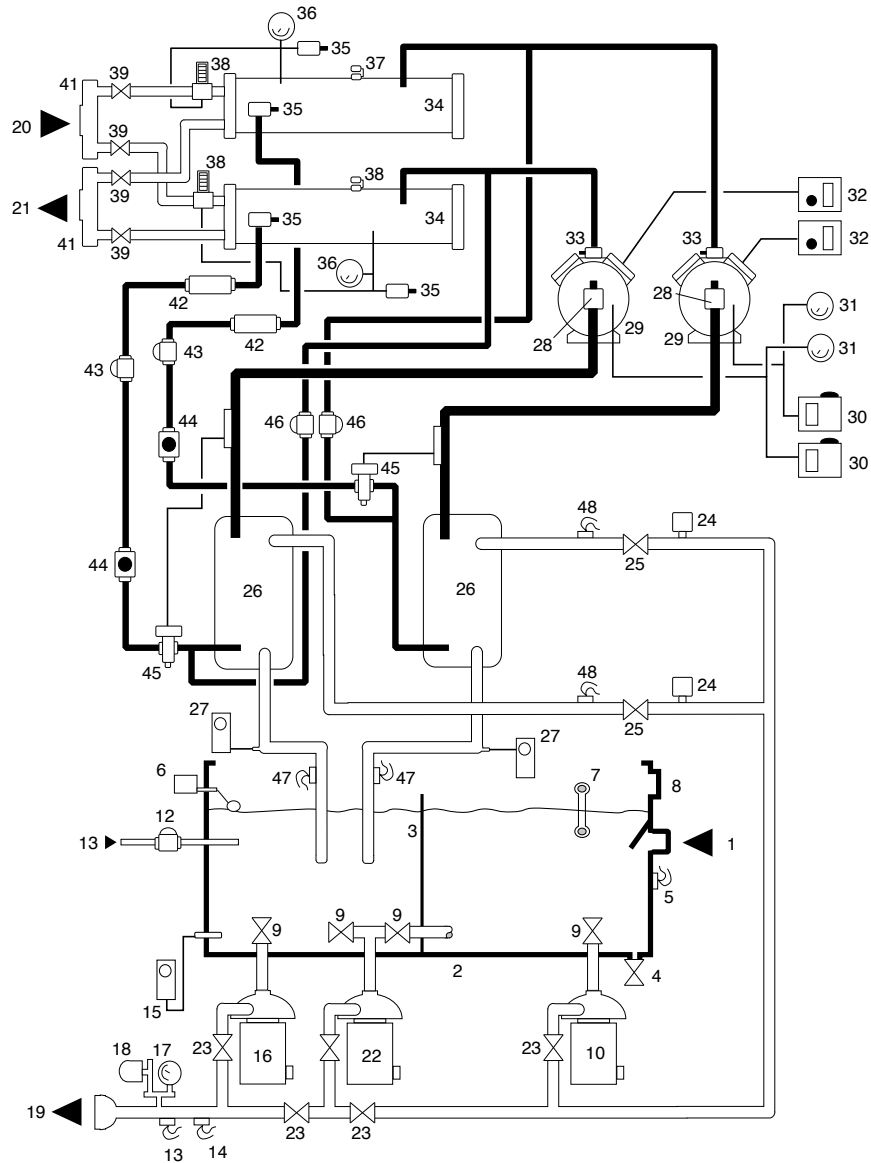

#	Item	#	Item	#	Item
1	From process connection	16	Process pump	32	High pressure limit
2	Tank assembly	17	Supply pressure gauge	33	Compressor discharge valve
3	Baffle plate	18	Alarm pressure switch	34	Condenser
4	Tank drain valve	19	To process connection	35	Service valve
5	Return probe	20	Condenser water supply connection	36	Head pressure gauge
6	Tank level control	21	Condenser water drain connection	37	Condenser safety relief valve
7	Level sight glass	22	Standby pump	38	Water regulator valve
8	Overflow to drain	23	Pump discharge valve	39	Condenser flow control valve
9	Pump suction valve	24	Flow safety switch	40	Condenser supply manifold
10	Evaporator pump	25	Factory adjusted flow control valve	41	Condenser return manifold
11	Water makeup solenoid valve	26	Evaporator	42	Filter-drier
12	Water supply connection	27	Freezestat	43	Liquid line solenoid valve
13	Supply probe	28	Compressor suction valve	44	Refrigerant sight glass
14	Control sensor	29	Compressor	45	Expansion valve
15	Alarm thermostat	30	Low pressure limit	46	Hot gas by-pass valve
		31	Low pressure gauge	47	Evaporator out temperature sensor
				48	Evaporator in temperature sensor

7.2 TYPICAL PRESS DROP

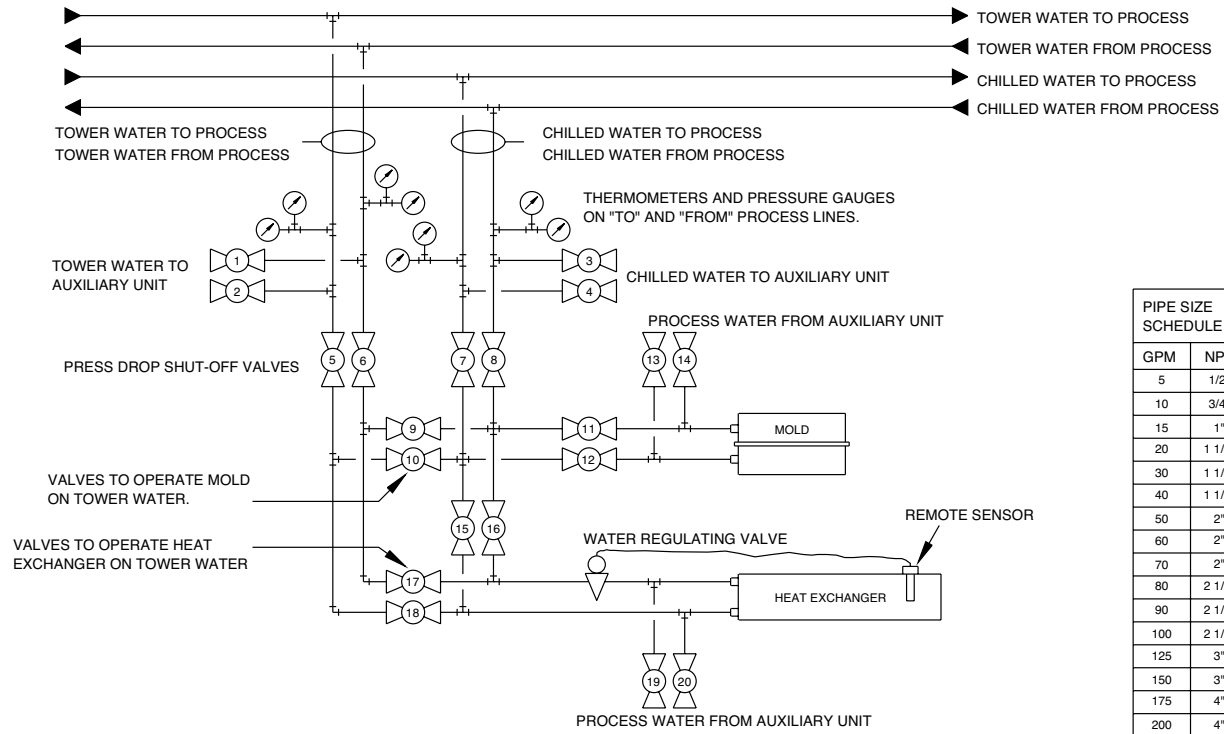

PIPE SIZE SCHEDULE	
GPM	NPT
5	1/2"
10	3/4"
15	1"
20	1 1/4"
30	1 1/4"
40	1 1/2"
50	2"
60	2"
70	2"
80	2 1/2"
90	2 1/2"
100	2 1/2"
125	3"
150	3"
175	4"
200	4"

VALVE POSITION CHART	
CONDITION	VALVES OPEN
WATER SUPPLY TO AUXILIARY EQUIPMENT	1,2,3,4
TO RUN TOWER WATER ON MOLD	5,6,9,10,11,12
TO RUN CHILLED WATER ON MOLD	7,8,11,12
TO RUN AUXILIARY EQUIPMENT ON MOLD	13,14
TO RUN TOWER WATER ON HEAT EXCHANGER	5,6,17,18
TO RUN CHILLED WATER ON HEAT EXCHANGER	7,8,15,16
TO RUN AUXILIARY EQUIPMENT ON HEAT EXCHANGER	19,20

- NOTES:
- 1) GPM @ 40 psig, 10°FAT
 - 2) INSTALL SERVICE UNIONS AND GAUGES AS REQUIRED.
 - 3) INSULATE ALL CHILLED WATER PIPING.
 - 4) PIPE SIZES ARE BASED ON FLOW RATES AND PRESSURE REQUIREMENTS. (SEE SCHEDULE)
 - 5) SEE VALVE POSITION SCHEDULE FOR OPEN REQUIREMENTS (ALL OTHER VALVES ARE CLOSED). MORE THAN ONE CONDITION MAY EXIST AT ONE TIME, WITH THE EXCEPTION OF MIXING TOWER AND CHILLED WATER SYSTEMS.

This drawing is supplied to demonstrate a possible piping configuration for the equipment and is general in nature showing pipe sizes and basic routing. It is not intended to be inclusive of every detail required for specific location and installation. Consult with a professional engineer to determine specific needs before installation.



7.3 TYPICAL VACUUM BREAKER / ANTI-SIPHON SYSTEM

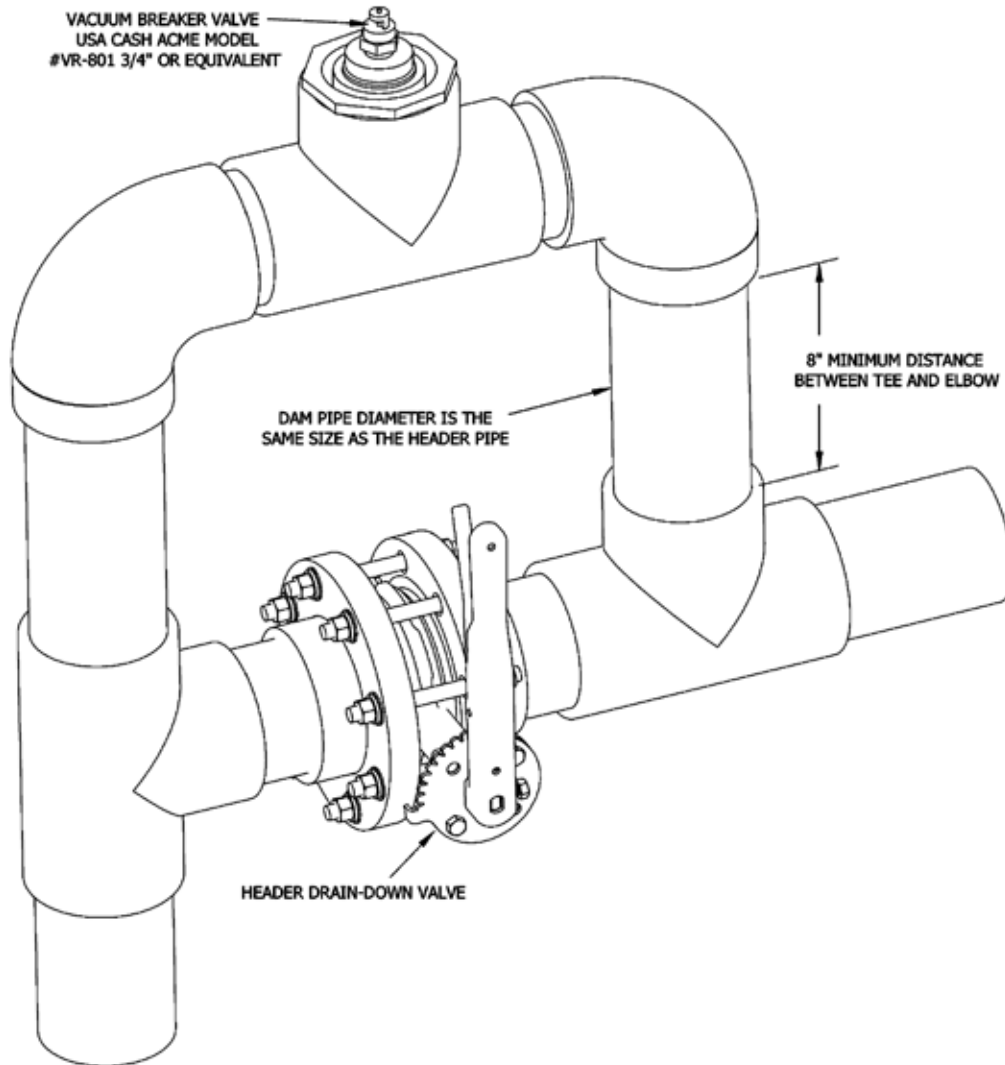

INSTALLATION NOTES:

1. The purpose of the vacuum breaker/anti-siphon (also called a drain-back dam), is to retain water in the header system during shut-down, and to eliminate air purge and shock to plumbing during start-up.
2. It is necessary to duplicate this arrangement on both the supply and return lines.
3. The drain-down valve allows header drainage for system maintenance and is closed during normal operation.
4. The vacuum breaker must be located at the highest point in the system, nearest to the tank to be most effective. A nipple length of 8 inches minimum is required to create sufficient vacuum to open the Cash Acme model VR-801.

8.0 APPENDIX

- 8.1** Operations Below 48F
- 8.2** Inhibited Propylene Glycol
- 8.3** Refrigerant Pressure - Temperature Chart
- 8.4** Chiller Capacity and Derate Chart

8.1 OPERATIONS BELOW 48°F FLUID OR 38°F AMBIENT

- A.** The chiller is never to be operated below 48°F leaving water temperature or installed in an area where the ambient temperature can get below 38°F without several precautionary measures.
- B.** Always confirm that the low pressure limit is set properly for the fluid type, temperature and refrigerant type used. Operating with an improperly set low pressure limit can damage the system which is not covered by the warranty.
- C.** Before readjusting the protective devices, a satisfactory antifreeze solution must be substituted for the recirculating chilled water. This mixture will consist of inhibited propylene glycol and water. Do not substitute an inhibited propylene glycol and water solution with common automotive type antifreeze. The chart on the next page outlines the glycol percentages at various water temperatures.
- D.** Fluid must be tested with a refractometer to verify proper glycol percentages for freeze protection. The ratio shall be according to the chart below. Too much glycol can cause capacity and control problems.
- E. DO NOT USE AUTOMOTIVE TYPE ANTI-FREEZE. WARNING:** do not use any type or brand of automotive antifreeze. Automotive antifreeze contains corrosion inhibitors - silicates - designed for compatibility with the materials in automotive engines. Silicates can gel and cause deposits to foul and insulate heat exchanger surfaces. In your chilling system that can mean higher energy costs, high pumping costs, and possibly even shut downs for system cleaning. We recommend the use of DowFrost or Monsanto DFS-1.
- F.** Once a satisfactory antifreeze solution is in place the protective devices may be adjusted and the control instrument can be unlocked to allow operation below 48°F. Protective devices include the low refrigerant pressure switches and freezestats, although not all units are equipped with dedicated freezestats.

G. The Unit may be equipped with :

1. Digital Low Pressure Switch
2. Mechanical Low Pressure Switch
3. Fixed Low Pressure Switch

H. Digital Low Pressure Switch

1. If the unit is equipped with the optional Digital Pressurestats, refer to Section 3.9 in this manual for information to adjust the Low Pressure Switch.
2. Adjust the low pressure switch according to the specifications in the chart on the next page.

I. Mechanical Low Pressure Switch

1. If your unit is equipped with an adjustable low pressure switch, adjust the low pressure switch according to the specifications in the chart on the next page.

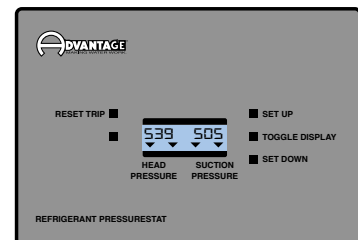

Digital Pressurestat Control



Adjustable low pressure switch

2. Adjust the low pressure switch according to the specifications in the chart on the next page.

J. WARNING: Never lower the cut out setting on the adjustable low pressure switch without adding glycol to the circulating system. Evaporator damage will result and this damage is not covered by the factory warranty.

K. Fixed Low Pressure Switch

1. If your unit is equipped with a non-adjustable “fixed” pressure switch with a factory low limit of 48°F this switch must be replaced with a switch with a lower limit. Note: Fixed Low Pressure Switches are not used on production models beyond the manufacturing date of January 2018.
2. The lower range low pressure switch can be obtained from the factory by calling 317-887-0729 and asking for the service department. The model and serial number of your unit is required.
3. A qualified refrigeration technician is required to change the switch though no gas recovery is required. The switch attaches to a threaded fitting on the refrigeration line.

L. Once all limit switches are adjusted, the temperature control instrument may be lowered to the desired operating temperature. Your control instrument may require moving a jumper or DIP switch to allow the temperature set points below 48°F. See the control instrument section of this manual or call the Advantage service department for specific instructions.

1. **Multizone Instruments.** Adjust the DIP switch to accommodate the expanded temperature range. Contact the factory for more information.

M. Once all safety provisions are made, the temperature control set point may now be lowered to the desired operating temperature.



Fixed low pressure switch

Refrigerant Low Pressure Switch Cut-Out & Cut-In Settings

Ambient Temperature	Operating Temperature	Glycol	Freeze Point	Cut Out Temp	Cut In Temp	R22		R134A		R410A	
						Cut-Out	Cut-In	Cut-Out	Cut-In	Cut-Out	Cut-In
39°F +	48° - 70°F	0%	32°F	32°F	36°F - 39°F	58#	63#	28#	33#	102#	111#
15° to 38°F	25° - 47°F	30%	10°F	10°F	15°F - 18°F	33#	38#	12#	17#	63#	72#
0° to 14°F	10° - 24°F	40%	-5°F	-5°F	0°F - 7°F	20#	25#	4#	9#	43#	52#
-10° to 0°F	n/a	45%									
-20° to -10°F	n/a	50%									

Ambient Temperature	Operating Temperature	Glycol	Freeze Point	Cut Out Temp	Cut In Temp	R404A		R407C	
						Cut-Out	Cut-In	Cut-Out	Cut-In
39°F +	48° - 70°F	0%	32°F	32°F	36°F - 3°9F	72#	79#	52#	58#
15° to 38°F	25° - 47°F	30%	10°F	10°F	15°F - 1°8F	44#	49#	28#	34#
0° to 14°F	10° - 24°F	40%	-5°F	-5°F	0°F - 7°F	29#	34#	16#	22#
-10° to 0°F	n/a	45%							
-20° to -10°F	n/a	50%							

High Pressure Cut Out (maximum) (with liquid receiver)

Refrigerant	Air-Cooled
R22	360#
R134A	260#
R407C	360#
R410A	550#
R404A	360#

8.2 REFRIGERANT PRESSURE-TEMPERATURE CHART

Refrigerant Pressure Temperature Chart

Temperature		Refrigerant					Temperature		Refrigerant				
°F	°C	R-22	R-410a	R-407c	R-134a	R-404a	°F	°C	R-22	R-410a	R-407c	R-134a	R-404a
-60	-51.1	11.9	0.9	10.0	21.6	-	27	-2.8	51.2	91.6	44.7	23.7	66.2
-55	-48.3	9.2	1.8	13.7	20.2	-	28	-2.2	52.4	93.5	45.9	24.5	67.7
-50	-45.6	6.1	4.3	17.1	18.6	-	29	-1.7	53.7	95.5	47.1	25.3	69.2
-45	-42.8	2.7	7.0	8.1	16.7	-	30	-1.1	54.9	97.5	48.4	26.1	70.7
-40	-40.0	0.6	10.1	4.0	14.7	-4.9	31	-0.6	56.2	99.5	49.6	26.9	72.1
-35	-37.2	2.6	13.5	1.1	12.3	7.5	32	0.0	57.5	101.6	50.9	27.8	73.8
-30	-34.4	4.9	17.2	1.5	9.7	10.3	33	0.6	58.8	103.6	52.1	28.6	75.3
-25	-31.7	7.5	21.4	3.7	6.8	13.5	34	1.1	60.2	105.7	53.4	29.5	76.9
-20	-28.9	10.2	25.9	6.2	3.6	16.8	35	1.7	61.5	107.9	54.8	30.4	78.5
-18	-27.8	11.4	27.8	7.2	2.2	18.3	36	2.2	62.9	110.0	56.1	31.3	80.2
-16	-26.7	12.6	29.7	8.4	0.7	19.8	37	2.8	64.3	112.2	57.5	32.2	81.7
-14	-25.6	13.9	31.8	9.5	0.4	21.3	38	3.3	65.7	114.4	58.9	33.1	83.5
-12	-24.4	15.2	33.9	10.7	1.2	22.9	39	3.9	67.1	116.7	60.3	34.1	85.2
-10	-23.3	16.5	36.1	11.9	2.0	24.6	40	4.4	68.6	118.9	61.7	35.0	86.9
-8	-22.2	17.9	38.4	13.2	2.8	26.3	41	5.0	70.0	121.2	63.1	36.0	88.6
-6	-21.1	19.4	40.7	14.6	3.7	28.0	42	5.6	71.5	123.6	64.6	37.0	90.4
-4	-20.0	20.9	43.1	15.9	4.6	29.8	43	6.1	73.0	125.9	66.1	38.0	92.2
-2	-18.9	22.4	45.6	17.4	5.5	31.7	44	6.7	74.5	128.3	67.6	39.0	94.0
0	-17.8	24.0	48.2	18.9	6.5	33.7	45	7.2	76.1	130.7	69.1	40.0	95.8
1	-17.2	24.8	49.5	19.6	7.0	34.7	46	7.8	77.6	133.2	70.6	41.1	97.6
2	-16.7	25.7	50.9	20.4	7.5	35.7	47	8.3	79.2	135.6	72.2	42.2	99.5
3	-16.1	26.5	52.2	21.2	8.0	36.7	48	8.9	80.8	138.2	73.8	43.2	101.4
4	-15.6	27.4	53.6	22.0	8.6	37.7	49	9.4	82.4	140.7	75.4	44.3	103.3
5	-15.0	28.3	55.0	22.8	9.1	38.8	50	10.0	84.1	143.3	77.1	45.4	105.3
6	-14.4	29.1	56.4	23.7	9.7	39.8	55	12.8	92.6	156.6	106.0	51.2	115.3
7	-13.9	30.0	57.9	24.5	10.2	40.9	60	15.6	101.6	170.7	116.2	57.4	126.0
8	-13.3	31.0	59.3	25.4	10.8	42.0	65	18.3	111.3	185.7	127.0	64.0	137.4
9	-12.8	31.9	60.8	26.2	11.4	43.1	70	21.1	121.5	201.5	138.5	71.1	149.3
10	-12.2	32.8	62.3	27.1	12.0	44.3	75	23.9	132.2	218.2	150.6	78.6	161.9
11	-11.7	33.8	63.9	28.0	12.6	45.4	80	26.7	143.7	235.9	163.5	86.7	175.4
12	-11.1	34.8	65.4	29.0	13.2	46.6	85	29.4	155.7	254.6	177.0	95.2	189.6
13	-10.6	35.8	67.0	29.9	13.8	47.8	90	32.2	168.4	274.3	191.3	104.3	204.5
14	-10.0	36.8	68.6	30.9	14.4	49.0	95	35.0	181.9	295.0	206.4	113.9	220.2
15	-9.4	37.8	70.2	31.8	15.1	50.2	100	37.8	196.0	316.9	222.3	124.1	236.8
16	-8.9	38.8	71.9	32.8	15.7	51.5	105	40.6	210.8	339.9	239.0	134.9	254.2
17	-8.3	39.9	73.5	33.8	16.4	52.7	110	43.3	226.4	364.1	256.5	146.3	272.5
18	-7.8	40.9	75.2	34.8	17.1	54.0	115	46.1	242.8	389.6	274.9	158.4	291.9
19	-7.2	42.0	77.0	35.9	17.7	55.3	120	48.9	260.0	416.4	294.2	171.1	312.1
20	-6.7	43.1	78.7	36.9	18.4	56.6	125	51.7	278.1	444.5	314.5	184.5	333.4
21	-6.1	44.2	80.5	38.0	19.2	57.9	130	54.4	297.0	474.0	335.7	198.7	355.6
22	-5.6	45.3	82.3	39.1	19.9	59.3	135	57.2	316.7	505.0	357.6	213.5	379.1
23	-5.0	46.5	84.1	40.2	20.6	60.6	140	60.0	337.4	537.6	380.9	229.2	403.7
24	-4.4	47.6	85.9	41.3	21.4	62.0	145	62.8	359.1	571.7	405.1	245.6	429.6
25	-3.9	48.8	87.8	42.4	22.1	63.4	150	65.6	381.7	607.6	430.3	262.8	456.8
26	-3.3	50.0	89.7	43.6	22.9	64.8	155	68.3	405.4	645.2	456.6	281.0	484.8

Italics indicates vacuum (inches of mercury)

Standard font indicates pressure (pounds per inch gauge)



8.3 INHIBITED PROPYLENE GLYCOL

- A.** To operate liquid chillers below 48°F, it is necessary to add **inhibited propylene glycol** to the circulating system to lower the freeze point and prevent damage to the cooling system. Inhibited propylene glycol contains corrosion inhibitors which are compatible with most industrial heat transfer surfaces. Inhibited propylene glycol is manufactured by:
- Dow Chemical - “DowFrost” (1-800-258-2436)
 - Monsanto “Therminol FS” (1-800-459-2665)
 - Advantage Engineering “Thermofluid” (1-317-887-0729)
- B.** Automotive anti-freeze must never be used in industrial heat transfer applications. Automotive anti-freeze contains silicate type corrosion inhibitors designed to be compatible with automotive components. In an industrial application, the silicates will form a gel on the heat transfer surface which will result in substantial reduction in cooling capacity and is virtually impossible to remove.

8.4 CHILLER CAPACITY AND DERATE CHART

- A.** Standard chiller rating is at 50°F. For all other temperature settings, output tonnage is altered as follows:

OUTPUT TEMPERATURE °F	FULL AVAILABLE % CAPACITY
60	105%
50	100%
45	90%
40	80%
35	70%
30	60%
25	50%
20	40%

NOTES:

1. If operation of the chiller at less than 48°F is required, an inhibited propylene glycol solution is required.
2. Consult factory for chiller operation below 20°F.
3. Ambient conditions affect air cooled chiller operation and capacity. Standard rating is at 95°F entering air temperature. For ambient air conditions greater than 95°F, chiller derating will occur. For ambients over 95°F consult factory.

END

© 2021 ADVANTAGE ENGINEERING, INC.

RE 20210805

